

# Passenger Terminal Facility Design Guide





## Commander's Charge



The AMC Passenger Terminal Facility Design Guide first appeared in the late 1990s to promote raising the standards of one of the most visible assets within the command, our Passenger Terminals. This edition recognizes the great progress we've made since then, and further supports the need to continue to evolve and enhance these design standards. Air Mobility Command has a rich heritage, both in mission and in its associated facilities, and to many within Department of Defense, these terminals represent the face of AMC.

Terminals symbolize one of the foundations upon which our flying mission rests. This guide helps us better understand many of the issues that impact the quality of our mission; the transportation of military personnel, their families, civilians, and retirees. We must do everything possible to ensure we design and construct functional, attractive facilities to support this key mission. We must ensure we make sound use of our investments to provide and maintain the best possible facilities our resources allow. By delivering quality terminals, we will significantly improve our mission capability, the quality of life for our own people and others we serve. All Logistic Commanders must share in the vision of terminal excellence depicted in this guide. With continued pride in AMC, let us strive for excellence in our work and in the people we serve.

A handwritten signature in black ink that reads "Raymond Johns".

RAYMOND E. JOHNS, JR.  
General, USAF  
Commander

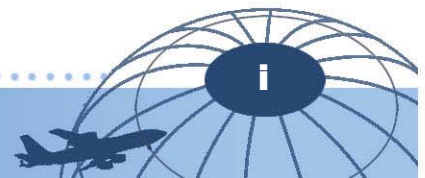

# TABLE OF CONTENTS

<b>Executive Summary</b> .....	v
<b>Chapter 1 - Project Development</b>	
• 1.1 Summary.....	1
• 1.2 Project Coordination.....	1
• 1.3 Project Initiation and Planning.....	2
• 1.4 Spatial Determination.....	3
• 1.5 Other Planning Considerations.....	4
• 1.6 Programming and Funding.....	6
• 1.7 Execution Strategy.....	7
<b>Chapter 2 - Site Criteria</b>	
• 2.1 Summary.....	9
• 2.2 Site Evaluation.....	9
• 2.3 Site Planning Specifics.....	11
• 2.4 Site Utilities.....	13
• 2.5 Site Security.....	13
• 2.6 Landscaping and Site Amenities.....	13
• 2.7 Sign Standards.....	13
<b>Chapter 3 - Facility Criteria</b>	
• 3.1 Summary.....	15
• 3.2 General Configuration.....	15
• 3.3 Departing Passenger Areas.....	15
• 3.4 Arriving Passenger Areas.....	21
• 3.5 Administrative Areas.....	22
• 3.6 Aircraft Support Areas.....	23
• 3.7 Building Support Areas.....	24
• 3.8 Functional Sizes and Adjacencies.....	25
• 3.9 Building Systems.....	32
<b>Chapter 4 - Interior Standards</b>	
• 4.1 Summary.....	35
• 4.2 General Design Criteria.....	35
• 4.3 Comprehensive Interior Design.....	35
• 4.4 Interior Finishes.....	35
• 4.5 Furnishings.....	37
• 4.6 Signage.....	38
• 4.7 Service Counters.....	38
• 4.8 Miscellaneous.....	39



# TABLE OF CONTENTS (Cont.)

## List of Figures

### Chapter 1

- Figure 1.1 Passenger Terminal Space Requirements Per AFM 32-1084..... 5
- Figure 1.2 Approximate Space Allocations..... 5
- Figure 1.3 Typical Project Process..... 6
- Figure 1.4 Typical Project Process..... 7

### Chapter 2

- Figure 2.1 Notional Site Plan..... 10

### Chapter 3

- Figure 3.1 General Terminal Components..... 15
- Figure 3.2 Departing Passenger Flow Diagram..... 16
- Figure 3.3 Arriving Passenger Flow Diagram..... 21
- Figure 3.4 Restroom Fixture Requirements..... 25
- Figure 3.5 Notional Space Summary for a Type IV Large Terminal..... 26
- Figure 3.6 Flow and Adjacency Diagrams for a Type IV Large Terminal..... 27
- Figure 3.7 Notional Space Summary for a Type II Medium Terminal..... 28
- Figure 3.8 Flow and Adjacency Diagram for a Type II Medium Terminal..... 29
- Figure 3.9 Notional Space Summary for a Type IB Small Terminal..... 30
- Figure 3.10 Flow and Adjacency Diagrams for Type IA and Type IB Small Terminals..... 31

### Chapter 4

- Figure 4.1 Approved Interior Finishes Schedule..... 36
- Figure 4.2 AMC Passenger Service Logo..... 38

## List of Appendices

- Appendix One - Terminal Color Boards - Cool and Warm Schemes..... A1.1
- Appendix Two - Family Lounge Color Boards - Five Schemes..... A2.1
- Appendix Three - Service Counter Drawings..... A3.1
- Appendix Four - Notional Terminal Floor Plans - Large, Medium, Small..... A4.1
- Appendix Five - General References..... A5.1



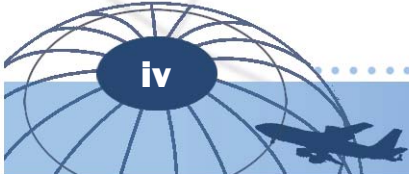
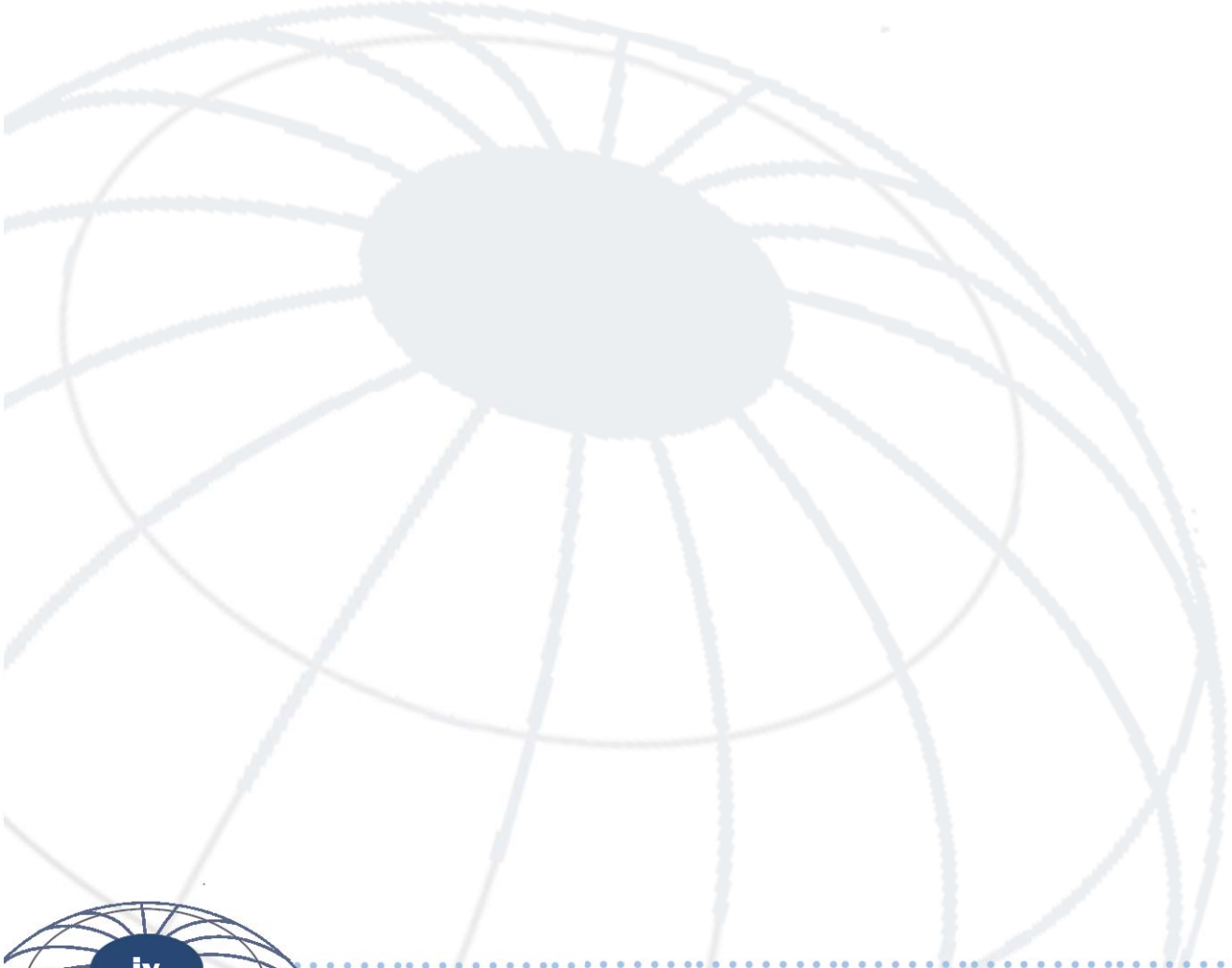

# Executive Summary

## A. Purpose

The mission of an Air Mobility Command (AMC) Passenger Terminal is to provide an interface between ground and air transportation. The terminals are also the arrival and departure points for each base and create a first and last impression of that location to military and civilian passengers. They must provide a safe, efficient, comfortable and familiar transfer of passengers and their baggage to and from aircraft and various modes of ground transportation. To accomplish this, basic service functions are required, as well as optional services that will aid the traveler. Terminal space requirements will vary by terminal category based on passenger load and base mission. The goal of this guide is to assist in planning, programming, designing, and executing projects for Passenger Terminals with higher overall quality, lower life cycle costs, and increased sustainability.

This Design Guide provides the basic criteria to organize, evaluate, plan, program and design AMC Passenger Terminals for the renovation of existing terminals and the design of new facilities. This information provides commanders and their staff important design considerations and aids them in validating project development. The Guide should not be considered a substitute for proper programming. It is intended for the Base Civil Engineer, Terminal Managers, review personnel, design architects, engineers, and other personnel associated with the terminal. The Guide will help all participants to better understand AMC Passenger Terminal requirements and their specific design criteria so they can more effectively participate in the project development process.

## B. Scope and Use

This Guide is applicable to all design projects for AMC Passenger Terminals at bases in both the Continental United States (CONUS) and Outside the Continental United States (OCONUS). The Guide outlines four major aspects of terminal improvements:

- Project Development
- Site Criteria
- Facility Criteria
- Interior Standards

The Guide presents three general size configurations for AMC terminals: large, medium and small. The design criteria presented will assist in determining specific program requirements, site development, and overall terminal design. Use this Guide in conjunction with other Department of Defense (DoD) and Air Force documents to successfully deliver projects. Incorporate additional information on unique program or design requirements of the terminal project at the installation level.

Appendix One provides two color board schemes, one cool and one warm, which coordinate with the AMC Passenger Service Logo and the five Family Lounge color schemes in Appendix Two. Appendix Three provides notional floor plans for the three primary terminal sizes, large, medium, and small. Appendix Four illustrates the primary counter designs utilized at the different functional areas within in the terminal.



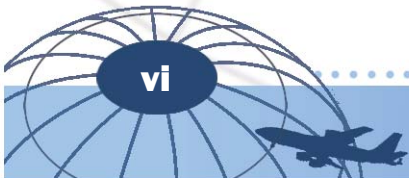



# Chapter 1 – Project Development

## 1.1 Summary

Project coordination and development are key steps in the beginning of any terminal improvement project. This chapter highlights individuals and organizations that require coordination for terminal projects. These terminal operations and organizations will potentially locate within the terminal facility. It will list both primary and optional organizations that might be present, their function, and the key players and decision makers. The chapter also outlines the process of developing, funding, and executing a project.

## 1.2 Project Coordination

Terminal requirements and design criteria are determined by a variety of Air Force and other governmental entities. Project success depends on the proper coordination of key organizations involved in administration, operation, and design.

### A. Primary Organizations

There are key installation organizations that impact terminal operations due to their responsibilities for base missions and operations. The key players include:

**Installation Commander** - Responsible for all base organizations and activities.

**Joint Basing (DoD Branch)** - Provides programming and engineering to tenant organizations. Responsibilities are the same as Installation Commander.

**Base Civil Engineer (BCE)** - Responsible for coordination of any base improvement project including construction and utilities.

**Communications Squadron (CS)** - Responsible for the operation of all communication systems and equipment serving the terminal.

**Security Forces (SF)** - Responsible for security of buildings, base perimeter, and gates.

**Anti-Terrorism - (AT)** - Ensures each facility on base meets the minimum AT standards.

**Air Mobility Command (AMC)** - Provides airlift, air refueling, special air mission, and aeromedical evacuations for U.S. forces.

**A4 Directorate of Logistics** - Has primary role of Passenger Terminal operations

**A7 Directorate of Installations and Mission Support** - Provides oversight of project design and programming for Passenger Terminals

**Air Force Material Command (AFMC)** - Headquarters organization responsible for mechanical conveyor equipment for all terminals and warehouses.

**Air Mobility Operations Wing (AMOW) / Air Mobility Operations Group (AMOG)** - Provides command and control support for en route locations.

**Air Mobility Squadron (AMS)** - AMC's en route organization that provides fixed and deployed maintenance, aerial port, and command and control functions.

**Aerial Port Squadron (APS)** - Responsible for all management of cargo and passenger transportation within the Military Airlift System.

**Logistics Readiness Squadron (LRS)** - Combines contingency planning, supply and transportation skills into one organization.

**Ancillary U.S. Agencies** - Establishes, manages, and controls processes for:

- Customs Service
- Immigration and Naturalization Service
- Public Health Service
- Agriculture Department



**Host Country** - May impose additional design and operations criteria including:

- Local Building and Fire Codes
- Customs/Immigration
- Agricultural Inspection
- Security Forces, Host Country Police, and/or Contracted Security Forces

## B. Additional Organizations

Depending on the location and size of the terminal, there may be other groups that have operations within a terminal and include:

### **Army & Air Force Exchange Service**

**(AAFES)** - Provides passenger conveniences within the terminal such as food service - snack bar, vending, rental cars and gift shops.

**Commercial Travel Office (CTO)** - Contracts with the Air Force to provide scheduling, ticketing information, and passenger services on military travel orders. CTOs work closely with the Traffic Management Office (TMO) to coordinate orders and commercial airline schedules.

**Traffic Management Office (TMO)** - Works closely with CTO in arranging travel for active duty and space-required passengers.

**Contract Air Terminal Operations (CATO)** - Contract personnel who operate terminals in various locations.

**Postal Service** - May have an office pick-up and/or pick-up/drop location.

**Red Cross** - Aids service members and their immediate families during emergencies and verifies emergency needs to service units so units can issue emergency leave orders.

**United Services Organization (USO)** - Offers hospitality services in selected terminals.

**Commercial Banks/Credit Unions** - Provide Automated Teller Machines (ATMs) and offer currency exchanges in foreign terminal locations.

## 1.3 Project Initiation and Planning

For a successful project, close coordination is important between the BCE and User Groups. Active communication throughout the process will ensure a mutually agreeable project is achieved. A high-quality design solution maximizes effective use of available space and efficiently provides for Passenger Terminal functions.

A well-coordinated facility program and design integrates architecture, interior design, engineering, and infrastructure throughout the design process. Consider the facility analysis, the existing terminal's structural, mechanical, electrical, and communications systems prior to planning any renovation project.

All new terminals and terminal additions shall have a conceptual requirements planning study completed and approved by both HQ Logistics (AMC/A4) and HQ Installations and Mission Support (AMC/A7).

Projects are classified as one of the following:

- Routine maintenance
- Larger repair
- Add/alter the existing terminal building
- New construction

### A. Project Initiation

Terminal projects typically start with a work requirements request (DSW/332) submitted to the CE Point of Contact (POC) or liaison. Depending on the size and scope of the project it can proceed as a simple work order. If determined that it warrants a larger project status, a draft DD Form 1391, Military Construction Project Data is prepared.

Terminal Facility Managers, with the help of Civil Engineering, follow these steps to achieve project completion:

- Identify project
- Define program scope
- Develop program requirements
- Prioritize within base program
- Attain funding
- Execute project

Once the project has been approved, the CE liaison enters the project into the automated Air Force project data base, ACES, making it an official project with a project number.

### **B. Special Considerations for Existing Buildings**

Criteria in this Design Guide also applies to renovation projects. When retrofitting existing terminals or converting an existing building into a Passenger Terminal, use a comprehensive and holistic condition assessment, including;

- Select a suitable permanent type of structure to warrant expenditure of funds
- The existing building and site must be large enough to accommodate the full scope and variety of terminal functions
- Provide open or relatively column free structural systems to better accommodate visibility and flexibility
- Modify the inside and outside image of the existing structure to reinforce its identity as a Passenger Terminal
- Audit and analyze the proposed facility for energy efficiency upgrades

During planning, refer to other DoD, Air Force standards and technical orders for further project development guidance.



*Terminal at Aviano AB, Italy*

## **1.4 Spatial Determination**

Space planning criteria defines the size, type, number, and functional relationship of operations for Terminals. Spatial requirements are determined in accordance with the spatial planning document for the Air Force, AFM 32-1084 Par. 5.22.2. (Cat. Code 141-784, for Air Passenger Terminals). Building space determination is primarily based on terminal passenger loads. Each base may also determine that different or additional requirements may be relevant to its local operations, which might increase project scope.

### **A. Design Issues and Relationships**

Space planning criteria for an individual terminal must consider the issues of overall building design and planning issues specific to the site. These considerations can affect the internal functional areas and spaces included in the facility.

The terminals are divided into five basic areas (Reference Chapter 3 for more information):

- Departing Passenger Areas
- Arriving Passenger Areas
- Administrative Areas
- Aircraft Support Areas
- Building Support Areas

### **B. Spatial Criteria Considerations**

Size limits are summarized in Figures 1.1 and 1.2; however, these are only approximate space allocations. Modify these spaces within the established criteria framework to fit specific project needs.

Include space for optional services when justified, but keep the total square footage within the Passenger Terminal allowances specified in AFM 32-1084 (i.e. USO, Red Cross). However, if an additional function identified in AFM 32-1084 has a requirement to be in the terminal, that square footage may be added to the total (i.e. Base Operations).



### C. Other Factors

Other factors that can affect the physical size of a terminal beyond just passenger loads include:

- Special functions
- Terminal mission
- Evaluation of current terminal operations
- Current Wing mission requirements
- Host Nation agreements affecting terminal operations

## 1.5 Other Planning Considerations

Consider the following four additional factors that will affect the planning process.

### A. Site Selection

Selecting a site for a Passenger Terminal is a critical design decision. Many variables are involved in the decision process and include the following criteria:

- Integrate with Base General Plan
- Immediate access to the flightline (direct location on the flight line not required)
- Locate terminals near the center of the apron where aircraft are parked to minimize travel to the aircraft
- Large enough site to accommodate the internal and external terminal requirements
- Space for expansion or adaptation of mission reassignments or aircraft
- Physical security requirements
- Utility availability and capacities
- Adequate parking

Reference Chapter 2 for additional site criteria.

### B. Design

All designs shall comply with Base Design and Architectural Compatibility standards. Building systems and interior design should be integrated into project planning. Include force protection requirements in the structural integrity of the building design.

The design process for either a renovation or new construction includes the following basic steps:

- Concept development
- Periodic design reviews
- Development of construction documents



*Terminal Conceptual Design*

### C. Flexibility and Expansion

For both site and building spaces, plan to accommodate changing patterns of use, alternative operating processes, and varying passenger loads in the design. For example, connect adjacent gate lounges by double doors or movable partitions to maximize flexibility.

Design the overall building form and structural system with consideration for potential expansion and additions, without over-designing the initial construction.

### D. Sustainability

Incorporate sustainable design and development (SDD) provisions throughout the planning, programming, design, construction, operations, maintenance, reuse, deconstruction, and demolition process. Identify building lifetime sustainable goals early in the project development. Design high quality/performing facilities with lower life-cycle costs. Buildings must be energy and water efficient, and environmentally friendly. Comply with current AF SDD policy and guidance and fully incorporate the Federal Leadership in High Performance and Sustainable Buildings (HPSB) Guiding Principles (GP).

Space Requirements per AFM 32-1084						
Category	Design Peak 3-Hour Passenger Load	Minimum Gross Area		Maximum Gross Area		Size*
		m <sup>2</sup>	sf	m <sup>2</sup>	sf	
IA	Under 100	372	4,000	650	7,000	Small
IB	101 - 250	651	7,001	1,860	20,000	Small
II	251 - 500	1,861	20,001	4,370	47,000	Medium
III	501 - 1000	4,371	47,001	7,430	80,000	Medium
IV	1000 - 2000	7,431	80,001	14,001	152,000	Large

Figure 1.1 Passenger Terminal Space Requirements per AFM 32-1084

\* Represents size categories referenced in AMCI 24-101 Vol.14

Approximate Space Allocations		
Size	Function	Percentage of Total Area (%)
TYPE IV - LARGE	Departing Passenger Areas - Lower Level*	25
	Departing Passenger Areas - Upper Level*	27
	Arriving Passenger Areas - Lower Level*	22
	Administrative Areas	7
	Aircraft Support Areas	9
	Building Support Areas	10
TYPE II & III - MEDIUM	Departing Passenger Areas	41
	Arriving Passenger Areas	21
	Administrative Areas	13
	Aircraft Support Areas	13
	Building Support Areas	12
TYPE IA & IB - SMALL	Departing Passenger Areas	60
	Arriving Passenger Areas	18
	Administrative Areas	7
	Aircraft Support Areas	11
	Building Support Areas	4

Figure 1.2 Approximate Space Allocations

\* Multi-level typical of large terminals



## 1.6 Programming and Funding

Programming and funding is the process of acquiring both the authority and resources necessary to complete a project.

The first and most important step in programming is acquiring the Requirements Document (RD), which validates the project scope and cost for a final Defense Department (DD) Form 1391. The final DD Form 1391 is the core of the programming process for a new project. Both 1391s and RDs are critical to project success and impact it through its development.

Funding and programming submittals must satisfy Air Force Planning Guidance, found in AFM 32-1084, Facility Requirements.

Plan for furniture and equipment procurement during the programming phase; however, these items must be acquired in the year of beneficial occupancy.

Reference Figures 1.3 and 1.4 for an Example Project Process. The following is a list of the most common ways for programming and funding projects:

### A. Military Construction (MILCON)

Construction projects with an estimated cost greater than \$750,000 are normally funded through the MILCON Program. Reference AFI 32-1021 for detailed information.

### Host, Tenant, and Supported Unit

**Responsibilities** - Provide services to tenant and supported units in accordance with:

- AFI 25-201, Support Agreement Requirements
- AFI 65-601, Vol. 1, Budget Guidance and Procedures

### Projects for On-Base Tenants and Supported Units

- Host installations will provide facilities needed by On-Base tenants from existing assets, if available. If adequate existing facilities are not available, or if the tenant otherwise requires construction or renovation of facilities for its sole use, the host installation prepares program-related documentation.

**Joint Basing** - Refer to Department of Defense Initial Guidance for BRAC 2005 Joint Basing Implementation, dated January 22, 2008, and Department of Defense Facilities Investment Supplemental Guidance for Implementing and Operating a Joint Base dated April 15, 2008.

**Installations in Foreign Countries** - In foreign countries, installations will follow guidelines outlined in Status of Forces (SOFA) or country-to-country agreements.

### B. Sustainment Restoration Modernization (SRM)

Projects are not defined by a dollar amount, but the limit is usually identified as \$750,000 (AFI 32-1032).

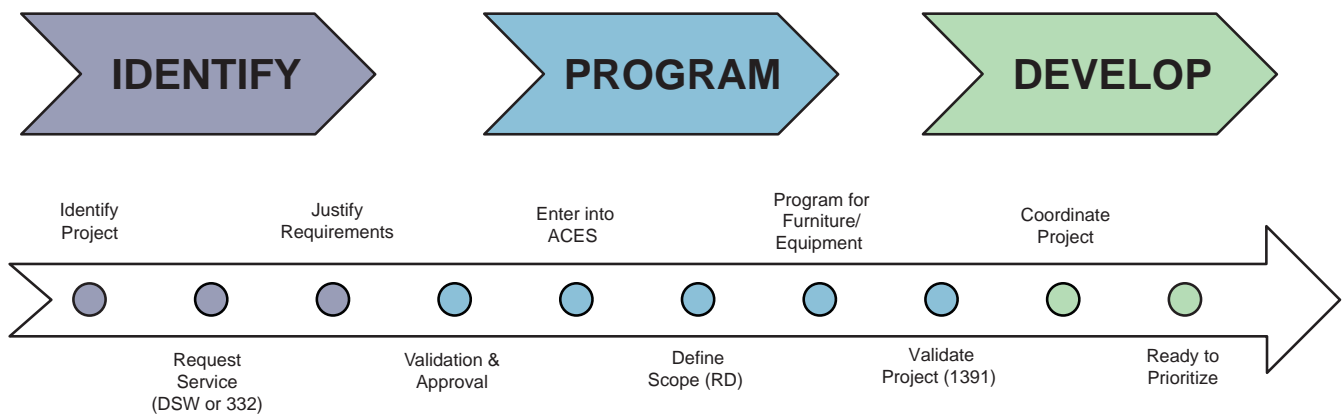
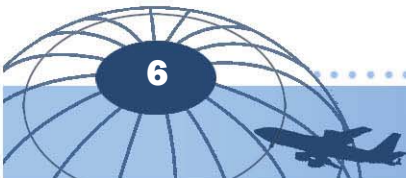

Figure 1.3 Typical Project Process



An SRM project is also defined as unspecified minor military construction, operational requirement, or a plan of maintenance and repair work necessary to produce complete and usable real property.

**C. Transportation Working Capital Fund (TWCF)**

TWCF is a funding source used to finance costs incurred in direct support of Strategic Airlift (C-5s, C-17s assigned to AMC TWCF Designated Units). It uses SRM funds for designated operational facilities, such as:

- Strategic Ramps Dedicated for AMC Use
- Passenger/Freight Terminals
- Hangars
- Fleet Services
- Maintenance/Operations Administrative facilities

**D. Army and Air Force Exchange Services (AAFES)**

AAFES provides funds for operations within the terminal, such as eating and vending areas.

**E. P341 Funds**

These funds specifically deal with projects that correct a life, health, or safety-threatening deficiency within the terminal. They are emergency funds that compete with other projects on the base.

**F. Host Nation**

When located overseas the Host Nation, in limited circumstances, provides funding for projects that are specifically required to meet their standards.

**1.7 Execution Strategy**

Depending on the funding strategy utilized, the execution strategy will vary. Several of the most common methods include the following:

- Military Construction (MILCON)
- Simplified Acquisition of Base Engineering Requirements (SABER)
- Indefinite Delivery / Indefinite Quantity Contract (IDIQ)
- Civil Engineering In-house
- Multiple Award Task Order Contract (MATOC)
- Job Order Contract (JOC)



*Ramstein Terminal*

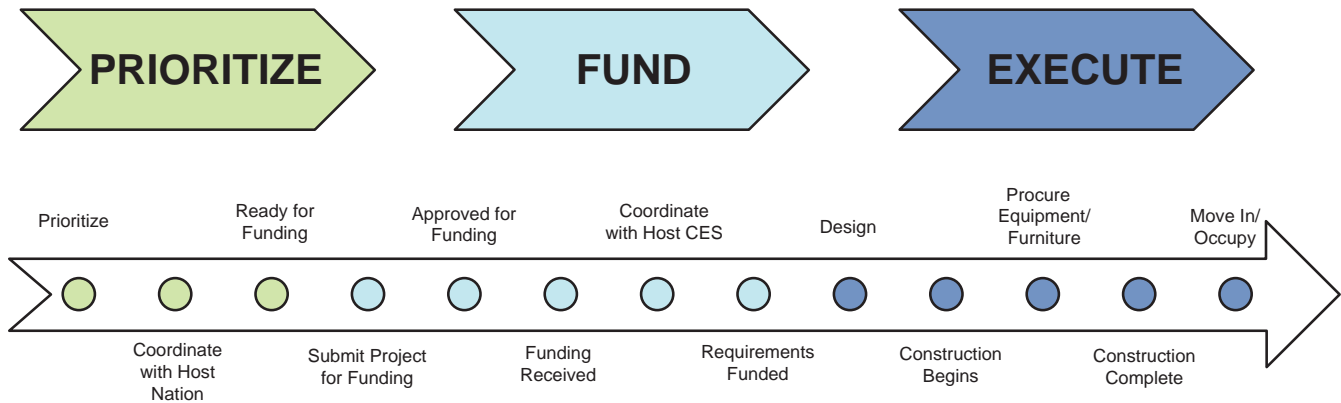

*Figure 1.4 Typical Project Process*







# Chapter 2 – Site Criteria

## 2.1 Summary

The site location and site development of Passenger Terminals are critical to the successful operation of the facility whether building a new terminal or adapting an existing structure. This chapter provides information on the necessary elements of selection and site design in order to develop site plans with:

- Facility expansion capacity
- Integrated site features such as topography
- Proximity or orientation to the flightline
- Energy efficiency optimization
- Ease of Accessibility
- Integration of all AT standards

Reference Figure 2.1 for Notional Site Layout.

## 2.2. Site Evaluation

Placing of a new terminal within the context of the base's flightline is predicated on a few specific factors which will influence that decision. In many instances, however, that selection is not possible due to the constraints of other existing facilities and must be adjusted to the realities of limited available space. The following criteria will help in determining the most suitable locations:

### A. Location

Select a site adjacent to the airfield that is both visible and has direct access from the main base roadway system. Locate the site in the vicinity of the Air Freight Terminal to share resources and operational efficiencies. Coordinate use of parking lot areas with neighboring facilities where possible.

### B. Local Context

Ensure that both the Base General Development Plan and any sub-area plans that deal with the specific area of the flightline are compatible.

Evaluate the terminal site in response to local climate conditions including:

- Protect from undesirable winds and solar gain
- Expose activity areas to the sun in cold climates
- Shade activity areas in warm climates



*Terminal Entry*

## C. Site Determination

Passenger Terminals require areas for the following exterior functions in addition to the facility itself:

- AT setbacks
- Entry and exit drives for site access
- Service drives and loading areas for deliveries
- Short-term parking for privately owned vehicles (POVs) and government-owned vehicles (GOVs)
- Ground transport pick-up/drop off zones
- Frontage or access to the airfield
- Long-term parking

Airfield frontage areas shall accommodate specific aircraft models expected at the particular terminal.



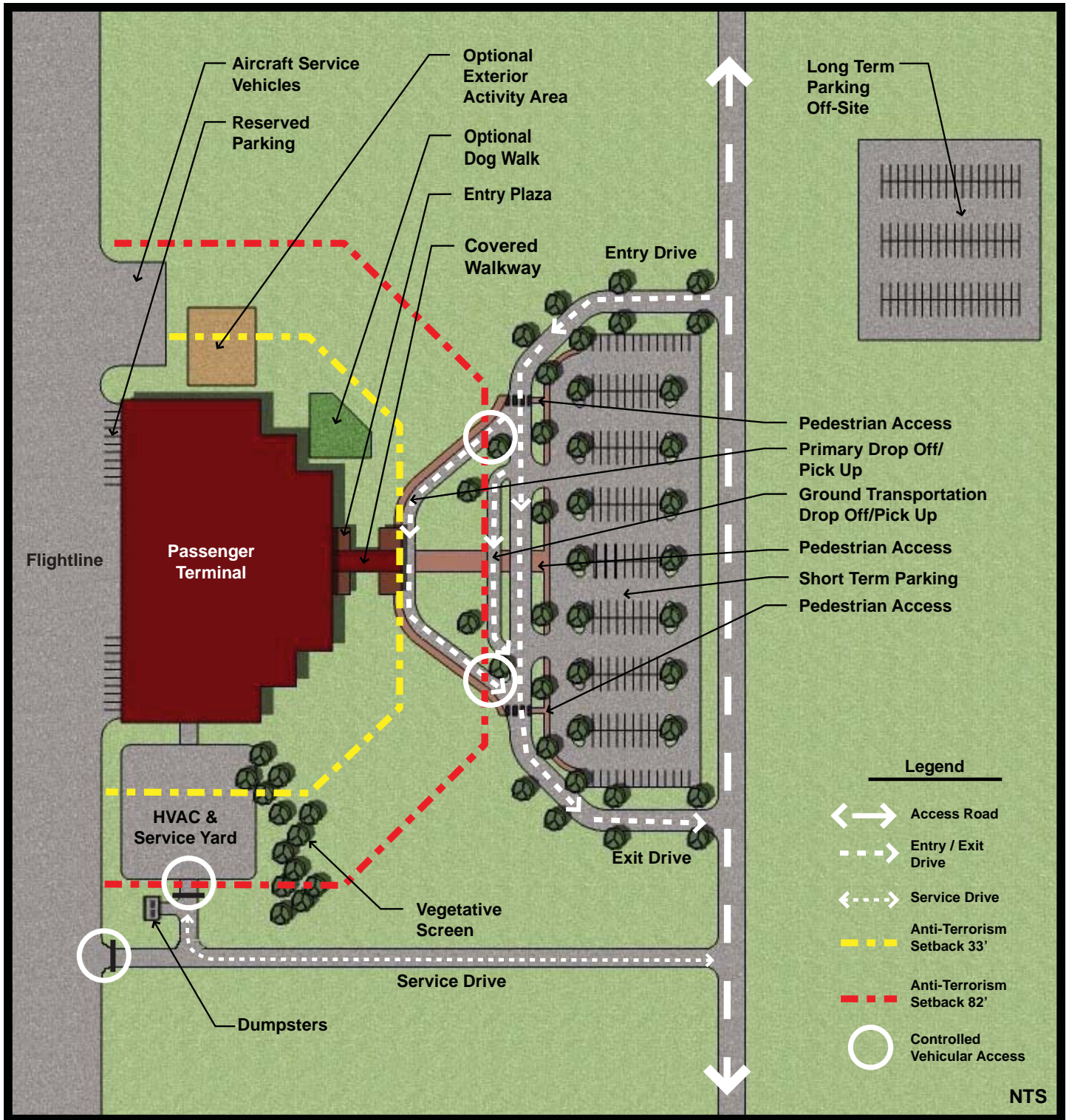
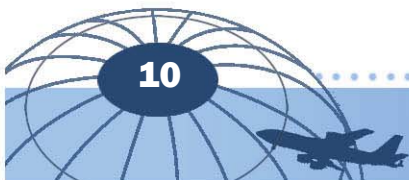

Figure 2.1 Notional Site Plan



## 2.3. Site Planning Specifics

Terminal site plans are composed of three major areas: Public, Flightline, and Service sides of the building. Each of these areas can be further divided into their functional components.



*Covered Entry Walkway*

### A. Public Side

Terminal main entry point for general access to the facility. Design the main entrance and site areas to accommodate typical passenger loads. Incorporate accessibility design features, such as curb cuts, ramps and signs as required by Architectural Barriers Act (ABA).

**Entry Plaza** - A paved area adjacent to the building with direct access to the Pick-Up/Drop-Off area. Size the area to accommodate the largest number of passengers or personnel expected to arrive at the terminal simultaneously. A covered walkway to pick-up/drop-off is preferred.

Include public address speakers, CCTV cameras, lighting, and telephones for passenger convenience.

**Pedestrian Access** - Sidewalks and crosswalks from short term parking to terminal must accommodate passengers with rolling suitcases and baggage carts. Use accent pavement at main entries and road crossings as a wayfinding device. Include area lighting at all crosswalks and plaza areas for safety.

**Main Base Access Roads** - Ensure that the

access road to the terminal is adequate to support the traffic volume, buses, and delivery trucks that service the building.

**Entry/Exit Drives** - Provide well-defined entry and exit drives for the Passenger Terminal to aid passenger navigation. Features include:

- Coordinated entry and exit drives with surrounding parking facilities
- Intersections with base access road that permit easy turning of buses and delivery trucks
- Separate parking lot access from ground transportation Pick-Up/Drop-Off areas and service drives
- Establish a one-way traffic flow in and out of large terminal areas

**Primary Pick-Up/Drop-Off** - Provide an area that allows convenient access to the terminal while meeting AT requirements. This area can be closed during higher Force Protection Conditions (FPCON).

- Include a drop arm gate or bollards to control access
- Limit vehicle speed using speed bumps
- Install “No Parking” signs within the controlled access area
- Provide Closed Circuit Television (CCTV) surveillance cameras and a Public Address (PA) system for flight and security announcements
- Provide an additional ground transportation pick-up/drop zone for busses and similar large vehicles beyond the 82 ft AT setback
- Include covered area with seating



**Short Term Parking** - Design parking lot facilities with clear circulation and a positive appearance that complements the terminal. The following criteria apply to parking lot design:

- Public/unrestricted-parking areas beyond 82 feet AT setback
- Handicapped accessible spaces as required by ABA
- Barrier-free access from the parking lot to main terminal entrances and exits
- Reserve spaces for Officer-in-Charge, Distinguished Visitors (DV) and employees
- Long-term parking for deployments may be off-site in some locations

**Dog Walk** - Where authorized, provide an area for walking family pets in a discrete location. Sign and provide litter bags for users to maintain sanitary conditions.

**Exterior Activity Area** - Where authorized, provide an area for outdoor play equipment to accommodate passengers with small children.

- Fully enclosed / fenced
- Availability of outdoor space will determine play equipment size
- Adjacency to and visibility from the Family Lounge is preferred (See Chapter 3, Section C.2 for additional information)
- Comply with Consumer Product Safety Commission (CPSC) requirements



*Exterior Enclosed Activity Area*

## **B. Flightline Side**

The side of the terminal that interfaces directly with aircraft and passenger flight operations. Site building on the flight line or as close to the flightline as practicable. Provide adequate access for baggage transport vehicles or trucks to facilitate operations and passenger access of planes.

Include specific areas for the following flightline activities:

- Passenger transport vehicles
- Baggage transport vehicles
- Aircraft service vehicles
- Fleet service vehicles
- Material handling equipment
- Limited staff parking area with controlled access

All Terminals - Provide adjacent space for busses or vans to transport passengers between the aircraft and terminal gate entrances.

Large 2-story Terminals - Accommodate jet ways directly from the building to the aircraft parking area.



*Jetway*

## **C. Service Side**

Place these activities in least visible location and separate from the public areas by means of landscaping or screen walls:

- Supply delivery area
- Utility equipment yard
- Trash containers/dumpsters
- Generator/fuel tank (if required)

Service drive areas of the terminal include controlled access drives connected directly to base access road. Provide sufficient area and adequate pavement thicknesses for large delivery trucks.



*Service Yard Screen Wall*

## 2.4. Site Utilities

Ensure capacity and location of all necessary utilities. Screen mechanical equipment yards and transformers with hard walls and/or landscaping. Comply with current AT standards for mechanical yards.

## 2.5 Site Security

Site security is a critical element due to the nature of the facility. Integrate AT features and ensure all elements comply.

Consider the following security features in area design:

- Incorporate permanent and removable vehicle barriers into site layout
- Use planters and/or walls to prevent vehicles from leaving designated areas (roads and parking lots) and driving too close to terminal
- Use a combination of landscaping berms and shrubs to deter attack over lawn areas
- Provide bollards as an effective means to allow pedestrian access to terminal while precluding vehicle access
- Integrate closed-circuit television (CCTV) into design and place as needed or desired elsewhere

Vehicle barrier designs should be both functional and meet the base Architectural Compatibility Standards.

For additional guidance on security measures, reference:

- AFMAN 32-1071 Security Engineering
- AMCI 24-101, Volume 14, Passenger Terminal Force Protection
- UFC 4-010-01, DoD Minimum AT Standards for Buildings
- UFC 4-010-02, DoD Anti-terrorism Standoff Distances for Buildings



*Terminal Entry with Bollards*

## 2.6 Landscaping and Site Amenities

Coordinate site planning and landscape elements with building features to create an integrated design of site and building. Provide paving, landscaping, site furniture, and plant materials that comply with the base Design Standards and Architectural Compatibility Plan (ACP).

## 2.7 Sign Standards

Provide appropriate directional and informational signs to clearly facilitate egress and exiting. Plan, control, and maintain signs as positive visual elements for site design. Minimize total number of signs within the terminal area to avoid a cluttered appearance. Signs must be consistent in style, placement, color, height, and language. Use base sign standards for consistent sign faces, backs, poles, and mounts. Reference the Air Force Sign Standards UFC 3-120-01 and the AMC Sign Standards for additional guidance.



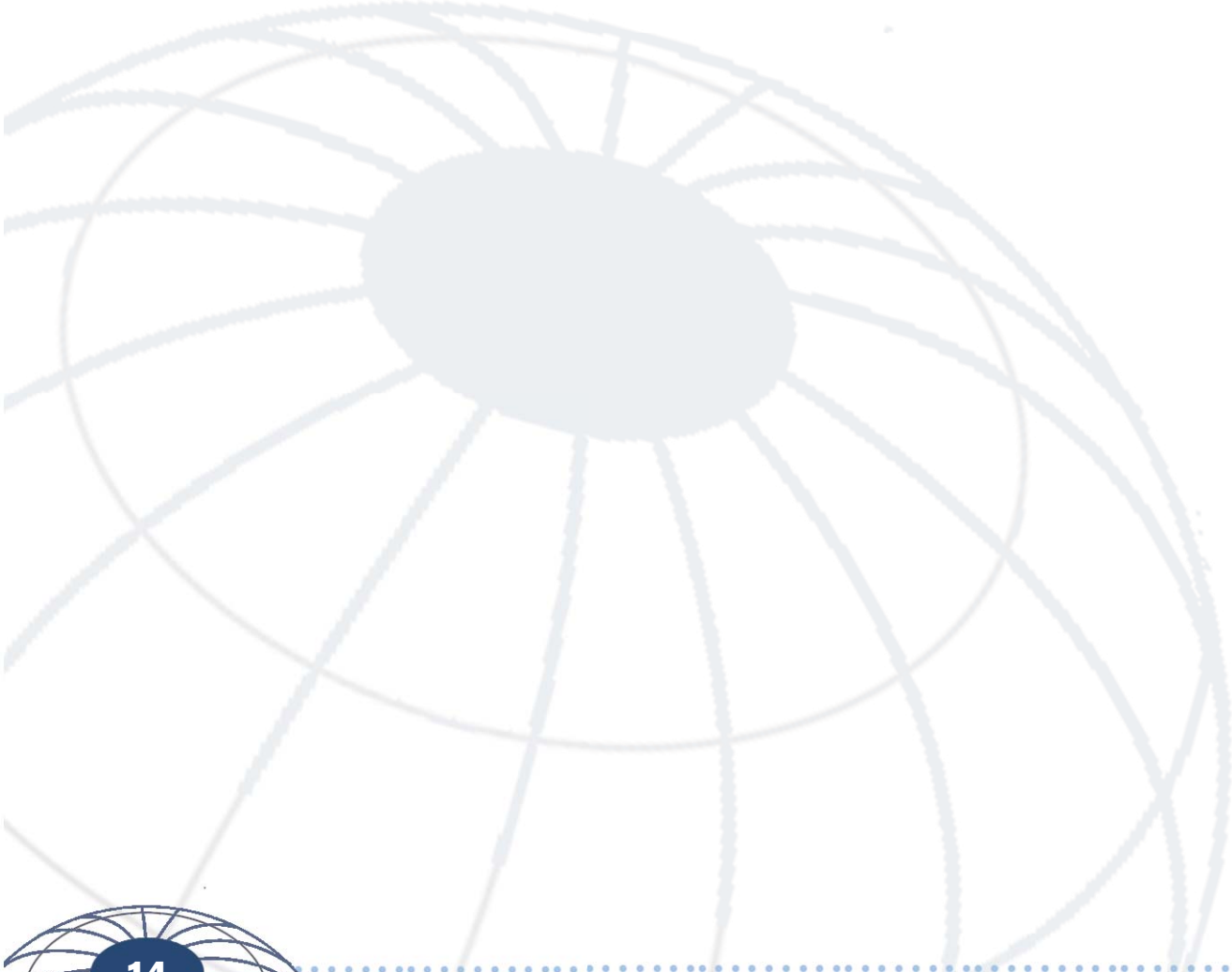

# Chapter 3 - Facility Criteria

## 3.1 Summary

Passenger Terminal facility criteria address functional aspects of Passenger Terminal layout. Terminals are composed of five major areas:

- Departing Passenger Areas
- Arriving Passenger Areas
- Administrative Areas
- Aircraft Support Areas
- Building Support Areas

This chapter presents area organization and adjacencies for Passenger Terminals. Primary design considerations include anticipated use and performance, organization, character, and adjacency relationships between spaces. Reference Figure 3.1 for General Terminal Components.

## 3.2 General Configuration

Criteria in this chapter is based on the three major terminal sizes: large, medium and small. Reference Appendix Three Notional Terminal Floor Plans.

Medium and Large Terminals - The main concept is to separate departing passengers from arriving passengers. Plan the Departing Passenger Area and

associated services on one side of the terminal and the Arrival Passenger Area and Baggage Claim on the opposite side. Separate Baggage Build-Up and Baggage Break-Down areas to minimize conflict between baggage handling vehicles. Reference Figures 3.5 - 3.9 for Flow and Adjacencies Diagrams and Notional Space Requirements.

Small Terminals - The floor plan consolidates functions into a smaller, shared footprint. Departure Passenger Area and the Arrival Passenger Area may be combined into one space during times of increased passenger loads. Reference Figures 3.10 and 3.11 for Flow and Adjacencies Diagram and Notional Space Requirements.

## 3.3 Departing Passenger Areas

The Departing Passenger Area constitutes the largest area of any terminal. It facilitates the checking in, processing, screening and departure of passengers. Reference Figure 3.2 Departing Passenger Flow Diagram.

### A. Entry

The entry is located at the front of the Central Lobby and is the single main entrance for passengers into the facility; it also can serve as an exit in small and medium terminals. Do not locate Service counters directly by the entry to avoid conflicts. A vestibule space is typically included at the terminal entry.

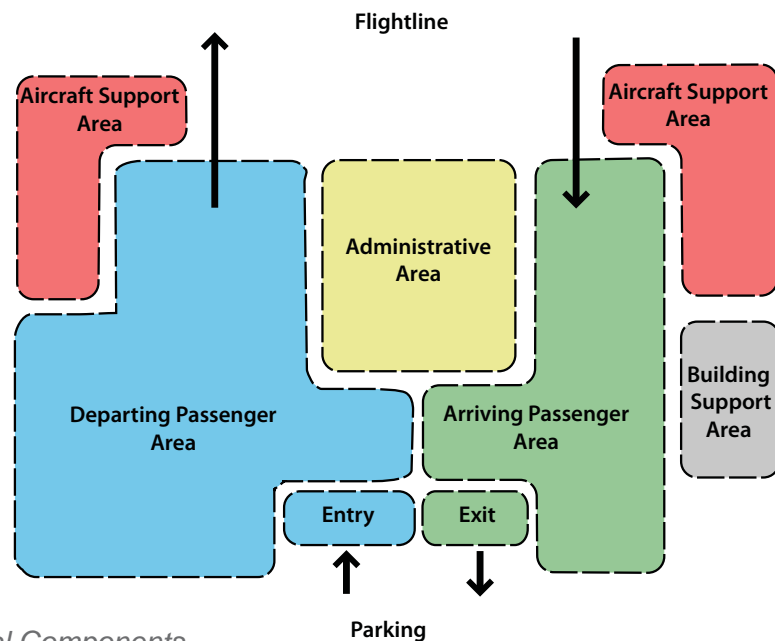

Figure 3.1 General Terminal Components



This space functions as an optional security screening area when threat conditions warrant as a Single Point of Entry. Configure space and adjacencies to avoid congestion. Provide additional power/data connections for temporary security screening equipment and include:

- Sufficient space to accommodate largest expected inflow of passengers for 100% security screening status
- Minimum space of 12-sq. ft. per person with several large pieces of luggage
- If the queuing area is outdoors, add an overhead canopy to protect those awaiting security screening from inclement weather
- Infrared heating and shelter from direct wind in cold climates
- Cooling and adequate ventilation in tropical climates

Reference 3.3, Section F for additional information

### B. Central Lobby

The Central Lobby serves as the core and provides access to all functions of the terminal. Include limited seating for waiting passengers. Provide direct access from entry and alternate security screening area.

**Large Terminals** - Provide additional upper lobby area on the second floor which functions as an extension of the ground floor Central Lobby.



*Two-Story Central Lobby*

**Passenger Service Kiosks** - Provide free standing kiosks with queuing in visible and accessible areas in Central Lobby near Flight Check-In Counter. Kiosks provide the following services:

- Sign-ups for Space-Available or Required Military Travel
- Mark-Present Sign-ups
- Standard Check-In

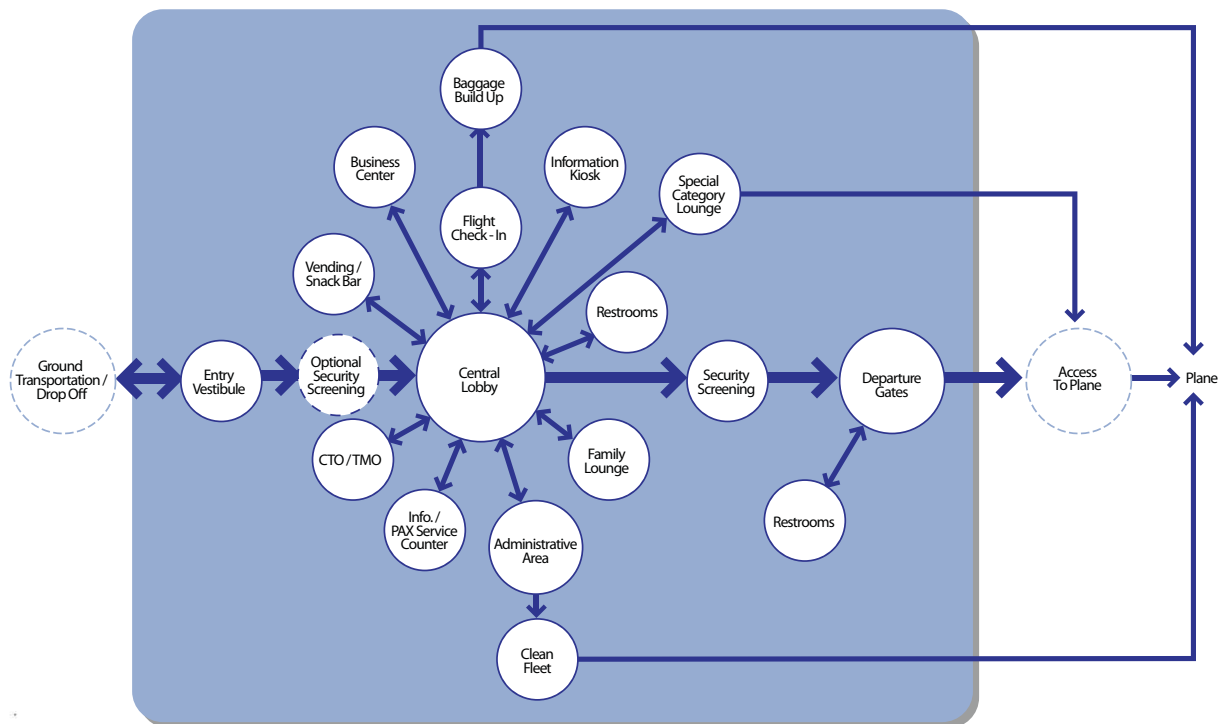

*Figure 3.2 Departing Passenger Flow Diagram*



**Service Counters** - Sub-areas within the Central Lobby cater specifically to departing passengers and include:

**Passenger Service** - A staffed counter which allows passengers to sign up for general travel, Space-A travel and duty stand-by calls. Locate the Passenger Service Counter so that it is visible from both the terminal entrance and from the central lobby.



*Passenger Service Counter*

**Traffic Management Office (TMO) and Commercial Travel Office (CTO)** - Provides travel agency booking services. Locate adjacent to Passenger Service Counter or may be located at a separate facility due to space limitations. Counter can be manned as required by passenger load.

**Information** - Supplies directions and answers questions regarding services and flights. Locate away from other counters to minimize congestion.

**Small Terminals** - Incorporate this unmanned function into the Passenger Service Counter.

**Flight Check-In** - A staffed area that is located away from the main entrance and other service counters. The counter should be in close proximity to the Dispatch and Supervisor/Funds Offices. Provide adequate queuing space, and include the following services:

- Boarding passes
- Baggage check-in
- Purchase of optional “in-flight meals”
- Process and transfer of baggage to the Baggage Build-Up area

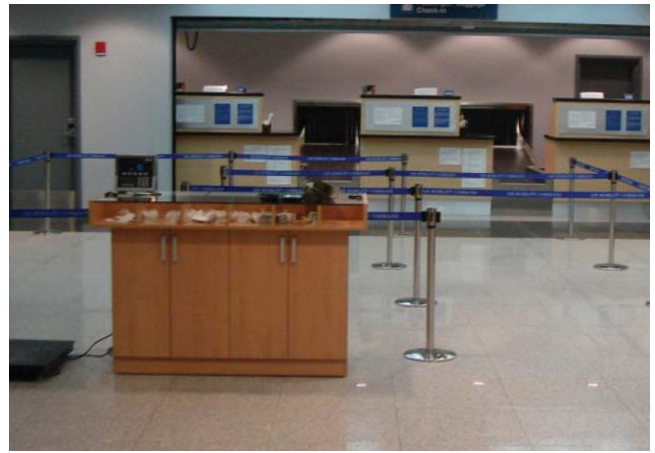

*Flight Check-In Counters*

**Small Terminals** - This counter operation is colocated with the Passenger Service Counter.

**Business Centers** - Provide work stations with data ports, additional charging stations for digital devices, “Wi-Fi” connections and printers for passenger convenience.

**Medium and Large Terminals** - This convenience is provided as a separate room adjacent to the Central Lobby.



*Business Center*

**Additional Services** - In locations that require them, optional services may be provided in or adjacent to the Central Lobby and include the following:

**Army/Navy/Marine Liaison Counter** -

Supports traffic from other services where warranted. Locate this counter next to the Passenger Service Counter.



**Immigration Station** - Locate a portable podium prior to Security Screening to service OCONUS passengers departing for CONUS locations. Passengers obtain an exit stamp in their passports where required.

### C. Upper Lobby Area

Terminals with a two story configuration will have an additional lobby area on the second floor that functions as an extension of the main floor Central Lobby. Locate additional functions such as food service, family lounge, business center, special category lounge, BX exchange and restrooms on second floor.

**Restrooms** - Locate directly off Central Lobby and Upper Lobby. Provide adequate number of fixtures to service the average passenger load. Reference Section 3.7 A for additional information.

Small Terminals - Provide one larger restroom to accommodate both the Departing and Arrival Gates.

### D. Lounges

Intended to provide comfortable and inviting spaces for travelers and their families to relax while in transit. Locate adjacent to the Central Lobby and include the following:



*Special Category Lounge*

**Special Category Lounge** - Serves high ranking military and civilian officials, distinguished visitors, or other special category passengers. Convenient to but separate from the Central Lobby, lounge

areas are divided into separate areas to allow multiple uses of the space simultaneously. Criteria includes:

- Direct access from the flight line
- Support for portable communication devices
- Cable TV/Telephone connections
- Variable light sources for occupants comfort
- Separate restrooms for men and women
- Higher quality finishes and upgrades compared to main terminal areas
- Exterior windows where possible
- Private office with desk or work station
- Baggage storage closet
- Small kitchenette with a microwave, sink, storage cabinets, and under-counter refrigerator

When accessed through corridor, upgrade the finishes in corridor to match the Special Category Lounge.

Small Terminals - Provide a single room with similar features including a private unisex restroom.

**Family Lounges** - Provide travelers with infants and small children dedicated family activity space. Locate adjacent to Central Lobby. In a large terminal, include the following:

- Main Lounge Area - Simulates the family home living area providing a comfortable and inviting space for families with comfortable seating, reading material and media devices
- Eating/Kitchen Area - Equip with tables, chairs, counter top with a sink, microwave oven, and small refrigerator
- Nursery Room - Furnish with cribs, rockers and bedding for infants
- Nursing Area - Private small room or discrete area set aside for nursing mothers
- Dependent Assist Restroom - Restroom sized for strollers with changing tables



*Nursery Room*

Medium or Large Terminals - May consist of several rooms; a seating area, restrooms, a separate crib room with change areas, and a kitchenette.

Small Terminals - Provide a single room with an adjacent restroom for diaper changing.

**Children’s Activity Area** - Dedicated space in the terminal or Family Lounge adjacent to Central Lobby. Furnish area with a variety of games and toys suitable for small children. Play area design guidelines include:

- Equipment visible from the Family Lounge
- Enclosed area in a tempered glass panel to reduce noise
- Area sized for local conditions



*Interior Children’s Activity Area*

## **E. Passenger Support Conveniences**

Local conditions determine which optional services are provided.

**Food Service** - Generally provided in some form in all terminals by the AAFES. Locate vending near waiting areas or common service functions to be accessed from the central lobby.

Large Terminals - May have dining areas, including food service preparation areas, dry food storage areas, refrigerator, freezer, staff lockers, and offices.

Small or Medium Terminals - May only have two or three vending machines with adjacent seating.



*AAFES Terminal Food Service*

**Base Exchange Annex** - In medium and large Passenger Terminals, provide small sundry items, snacks and gifts adjacent to Central Lobby or Upper Lobby.

**Ground Transportation Counter/Kiosk** - Provide space for rental car, base transport, taxicab, bus, subway, or rail transportation information. In small and medium terminals, the Information Counter may provide this function.

**Automated Teller Machines** - ATMs may be supplied by local banks or credit unions. Locate in visible and accessible area.





Telephone Area

**Telephones** - Provide area with on-and-off bases access telephones. In large terminals provide a separate area for this activity. In small and medium terminals, this area can be located centrally for both departing and arriving passengers.

### F. Security Screening Area

The major check-point prior to entering the Departure Gate Area. This area includes space for passengers processing through security screening equipment. Consider the following:

- Configure and place both before gate and at entry to avoid congestions with other functions in Central Lobby
- Minimize queuing space
- Large X-Ray machines, magnetometers, trays, tables, and security personnel
- Secondary security checks with hand, scanners, and the visual inspection of baggage
- Additional power/data connections for security screening equipment



Security Screening Area

Determine number of X-Ray and magnetometer screening stations based on the number of departing passengers processed on a daily basis.

### G. Departing Passenger Gate Area

This is the final waiting area for passengers prior to boarding the aircraft. Once entered, passengers may not return to Central Lobby without being rescreened.

**Gate Area Corridor** - The transition area just past Security Screening that provides access to the gates and restrooms in medium and large terminals. In small terminals, gate access may be direct from Security Screening.



Gate Area

**Departure Gate** - Provides a seating area for departing passengers and secure access to planes. Gate may be used by arriving passengers if needed with proper security and separation. Include the following:

- Passenger Agent Counter or podium in a visible location at each gate
- An information board for flight number, destination and departure
- Secured gate areas, using “movable” walls, to prevent contact between passengers from different flights
- Space seating rows to accommodate passengers with baggage

**Gate Area Restrooms** - Locate directly off Gate Corridor or Gate Area. Provide adequate number of fixtures to service the average passenger load. Reference Section 3.7 A for additional information.

**Small Flight/Departure Gate** - In large terminals with second floor Departure Gate Areas, include a ground level Gate to access smaller aircraft. Include security screening and direct access to gate without separate restrooms.

### 3.4 Arriving Passenger Areas

Although equally as important as the departing passenger areas, the arriving passenger areas require less space than the departing passengers since it is primarily a transit space. Reference Figure 3.3 for Arriving Passenger Flow Diagram.

#### A. Arrival Gate

Arriving passengers proceed directly from the aircraft to the Arrival Gate waiting area. Consider the following:

- Size area smaller than Departing Gate areas to accommodate Immigration and Customs briefings where required
- If located on second floor, provide stairs and elevators to arrival processing and Baggage Claim area on ground floor
- When necessary, with proper security and separation, may be used for departures

**Restrooms** - Locate directly off Arrival Gate. Additional restrooms may be located prior to the Customs/Agriculture Counter. Provide adequate number of fixtures to service the average passenger load. Reference Section 3.7 A for additional information.

#### B. Immigration Station

Immigration clearance may be accessed from the gate and prior to baggage claim. Supply a portable podium for agents that address host nation requirements. Procedures will differ by country and by origination of flight.

#### C. Baggage Claim

The Baggage Claim area should be sized appropriately to include the following:

- Baggage conveyors
- Minimal seating to avoid congestion in front of conveyors
- Immigration Station and Customs Counter
- Oversized luggage claims area
- Restrooms



*Baggage Claim and Customs Area*

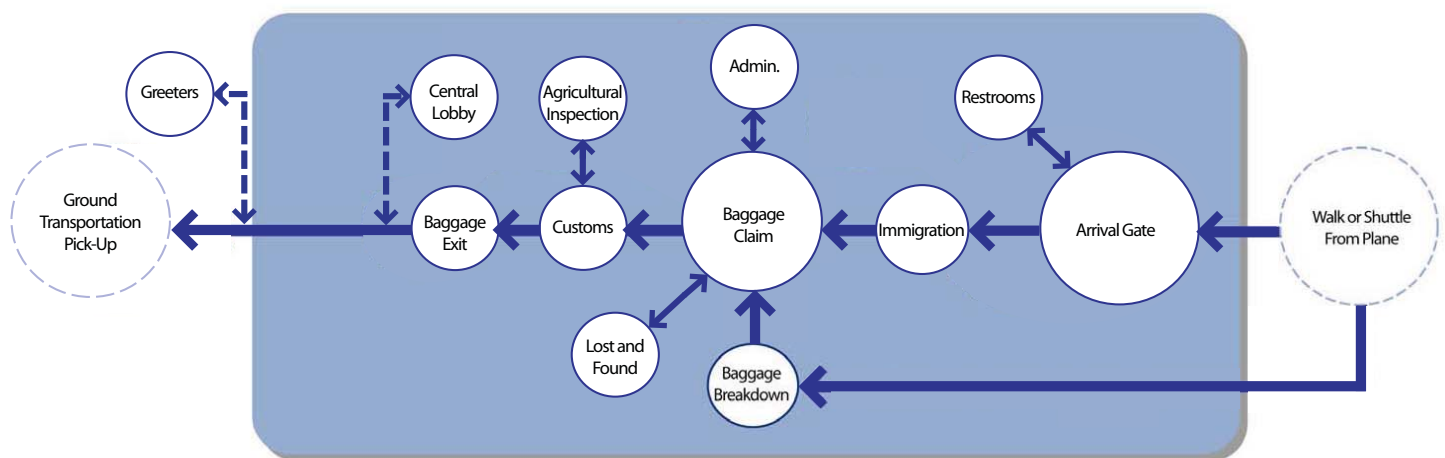

*Figure 3.3 Arriving Passenger Flow Diagram*



#### D. Lost and Found

Provide a room adjacent to the Baggage Claim area for this administrative support function. Size space for a work station and provide lockable closet for unclaimed or mistagged baggage.

#### E. Customs/Agriculture

Customs is the final checkpoint prior to entering or returning from a foreign country:

- After claiming baggage, passengers queue for Customs inspection
- Queuing should not conflict with bag security examination or circulation
- Identify the point beyond which passengers should not proceed until directed

Passengers may arrive from a location where baggage was not screened. In such cases, passengers must pass back through the security screening area if they access ticketing or departing areas.

Terminals with more elaborate Customs procedures may require an additional search room, vault and an Agriculture Inspection Office.

#### F. Passenger Support Conveniences

Optional activities provided to travelers. Local conditions determine which services are provided. Most are located in or adjacent to Central Lobby.

**Baggage Carts** - Provide baggage carts in areas designated by local management.

**Hotel/Lodging Information** - Provide an Information Kiosk/Station with information on lodging, area hotels and area attractions. This Kiosk should be located outside of the Customs area (i.e. after passengers pass through customs).

Small Terminals - May be incorporated into Central Lobby.

#### G. Baggage Claim Exit

Provides direct exit from terminal or back into Entry Vestibule. Designs should incorporate the following:

- No direct re-entry upon exit
- Monitored by Security CCTV
- Greeting area outside the Customs/Baggage Claim Sterile (secure) Area
- Covered walkway to primary pick-up/drop-off
- Exterior covered area which accommodates both greeters and passengers awaiting ground transportation



*Baggage Claim Exit*

### 3.5 Administrative Areas

The Passenger Terminal includes a variety of administrative support spaces. Some spaces directly relate to passenger processing while other internal offices have little or no contact with passengers. Specific requirements for administrative spaces are determined using AFM 32-1084 and command guidelines.

#### A. Required Administrative Offices

These offices are directly involved in the daily operations of the terminal and include:

**Terminal Management** - Locate offices to have direct access to other functional areas, especially the Central Lobby. Open-plan office space with work stations is preferred.

Provide offices for the following individuals:

- Officer-In-Charge
- Superintendent
- Non-Commissioned-Officer-In-Charge
- Transportation Assistant

**Shift Supervisor/Funds** - Private office, located adjacent to Flight Check-In Counter.

**Dispatch** - Coordinates ground transportation of passengers and baggage with aircraft and gates. Locate office adjoining Shift Supervisor/Funds Office and Break Room.



*Dispatch Office*

**Break Room** - Size to meet the needs of local staff; equip with refrigerator, microwave, sink, counter space, and seating. Locate near Dispatch and Shift Supervisor/Funds offices. Large terminals may include additional break area in Terminal Management Area. In small terminals, space may double as training room.

**Storage** - Provide separate storage rooms to accommodate administrative, office, and janitorial supplies.

**Traffic Management Office (TMO) and Commercial Travel Office (CTO)** - Locate adjacent to Passenger Service Counters and other offices.

**Customs/Immigration/Agricultural Inspection Office** - Locate near the Customs Counter in the arrival area. May require separate search room with access to Arriving Gate Area.



*Customs Inspection Area*

## **B. Additional Administrative Offices**

In locations where required, optional offices may be provided.

**Conference/Training Room** - Size to accommodate local staff requirements. Provide computer and AV connections for training programs.

**Red Cross** - The Red Cross may be in the terminal, convenient to departing passengers.

**Army/Navy/Marine Liaison** - Locate immediately adjacent to the Army/Navy/Marine Liaison Counter.

## **3.6 Aircraft Support Areas**

Directly supports terminal ground operation functions of departing and arriving aircraft. Accessed by staff only, these activities include:

- Baggage Screening
- Baggage Build-Up
- Baggage Break-Down
- Clean Fleet Services

### **A. Baggage**

These areas must be secure and weather protected. Interior spaces are preferred. The optimum room size and shape will be determined by means of delivery and mix of aircraft. Provide space for baggage built on or removed from 463L pallets (88" x 108" max.), roller systems, and maneuverability of



material handling equipment, such as forklifts. Small batches of baggage are taken directly to the aircraft by a terminal truck. Provide direct exterior access for personnel and vehicles.

**Small Terminals** - These functions may be located on the exterior of the facility; Baggage Build-Up and Break-Down can be collocated.



*Baggage Screening Area*

**Baggage Screening** - Provide adequate space in larger terminals for baggage X-Ray equipment. Allow space between baggage rows for military dog security searches. Baggage screening is normally located within Baggage Build-Up.

**Baggage Build-Up** - After baggage is tagged at the Check-In Counter and screened for departing flights, it is conveyed to a Baggage Build-Up where it is sorted by destination. The conveyor originates behind the Flight Check-In Counter and extends into the Baggage Build-Up. Provide sufficient length to enable efficient screening, sorting, and unloading, with direct Flightline access.

**Small Terminals** - A hand pass from the Flight Check-In Counter to Baggage Build-Up is sufficient.

**Baggage Break-Down** - After baggage is unloaded from arriving aircraft, it is transported to the Baggage Break-Down Area. The conveyor then transfers the baggage into the Baggage Claim Area.

**B. Clean Fleet Services** - Provides originating aircraft and in-transit aircraft with expendable and non-expendable supplies such as blankets, pillows, etc. Serves primarily as a warehouse-type space

with shelving storage for supplies, office space and work area with tables. Locate adjacent to flightline access for ease of loading and unloading of supplies. Provide direct exterior access for personnel and vehicles.

### 3.7 Building Support Areas

All facilities require support spaces for basic building functions. These utilities are the backbone of the building; they provide for the daily operations and include the following:

**A. Restrooms** - Place at various locations throughout the Terminal to include Central Lobby, Departing Gate Areas, Arriving Passenger Gate Areas, Food Service areas, Special Category Lounge, and Family Lounge.

Restrooms for Central Lobby, Departing Gate, and Arrival Gate Area include:

- Infant changing stations
- Diaper disposal receptacles
- Handicapped accessible facilities
- Electrical outlets beneath mirrors for electric razors or hair dryers
- Increased ventilation requirements
- Include drinking fountains at all restroom locations

Restrooms for Central Lobby, Departing Gate, and Arrival Gate Area may also include:

- Benches and clothes hooks for personnel wishing to change clothes or uniforms
- Showers in Central Lobby
- Family assist areas in terminals with heavy concentrations of families

**Small Terminals** - Provide central restroom off the Central Lobby to accommodate the functions of the Central Lobby, Departing Gate, and Arrival Gate Area.





Restroom

Fixture count for terminals also requires local input as to passenger load requirements. Historically there have been too few fixtures. Verify with local authorities fixture count based on current passenger loads. Reference Figure 3.4 for determining fixture requirements. Numbers are an approximation and should be used with appropriate code referral.

Number of Fixtures Required in Restroom Facilities in Each Functional Area*		
PEAK LOADING PER FUNCTIONAL AREA (PER GENDER)	MALE RESTROOM	FEMALE RESTROOM
1-15	1	1
16-35	2	3
36-55	3	5
56-100	4	6
101-155	5	8
156-205	6	10
206-250	7	11
251-300	8	13
301-350	9	14
351-400	10	16
401-450	12	19
451-500	13	21
501-550	14	22
551-600	15	24

\*Functional areas refer to Central Lobby, Passenger Departing Gates, and Arriving Gates,

Figure 3.4 Restroom Fixture Requirements

**B. Custodial Services**

Provide janitorial closets at several locations throughout the Terminal. Include space for cleaning supplies, equipment and a mop sink. Provide separate space for housekeeping supplies if necessary.

**C. Mechanical Room**

Size rooms and doors to accommodate equipment and maintenance. Locate on an exterior wall of the terminal with direct secure access.

**D. Electrical Room**

Size rooms and doors to accommodate equipment and maintenance. Locate on an exterior wall of the terminal with direct secure access and typically adjacent to the Mechanical Room.

**E. Communications Room**

Size the rooms and doors to permit efficient movement and maintenance of equipment. Condition space and locate room in the interior of the terminal. Coordinate with Communication Squadrons for current standards and protocols.

**3.8 Function Sizes and Adjacencies**

This section provides notional space allocations and notional plan diagrams for the three terminal sizes. Reference Appendix Four for notional terminal floor plans (not definitive designs).

Each base develops its own program requirements and design solutions appropriate to its local functions, operating patterns, scope, site constraints, and architectural character, in accordance with AFM 32-1084, AMCI 24-101, Volume 14, and this Guide.

## Large - Type IV Passenger Terminal

Consistent traffic from commercial aircraft with large passenger capacities generates passenger loads that justify a large terminal. Large terminals operate more efficiently in a two-story configuration that minimizes the building footprint. Reference Figure 3.6 for Flow and Adjacency Diagram.

Provide access at grade from curb-side since multi-level, curb-side access is typically cost prohibitive. Divide the lower level space into departing and

DEPARTING PASSENGER AREAS - LOWER LEVEL	11,900
Entry Vestibule	200
Central Lobby	10,000
Passenger Support Conveniences	TBD
Passenger Service Kiosks	100
<u>Service Counters</u>	500
<ul style="list-style-type: none"> <li>Passenger Service</li> <li>TMO/CTO</li> <li>Information</li> <li>Flight Check-In</li> </ul>	
<u>Optional Counters</u>	TBD
<ul style="list-style-type: none"> <li>Red Cross</li> <li>Rental Car</li> <li>Army, Navy, Marine Liaisons</li> </ul>	
Phones/ATM	100
Restrooms	500
Passenger Gate	500
DEPARTING PASSENGER AREAS - UPPER LEVEL	33,850
Upper Level Lobby	5,000
<u>Departing Passenger Gate Area</u>	14,000
<ul style="list-style-type: none"> <li>2 Departure Gates</li> <li>Passenger Agent Counter</li> <li>Passenger Seating Area</li> <li>Vending</li> </ul>	
Business Center	200
Special Category Lounge with Restrooms	2,000
Security Queue	2,000
Security Screening	750
Food Service	4,000
Family Lounge with Restrooms	2,900
Gift Shop and Base Exchange Annex	500
Restrooms	500
Boarding Corridor	2,000

arriving functions and arrange these functions around separate lobbies at grade.

Locate some departure gate areas on the upper-level. Provide access to the departure gate areas and all other functions on the upper-level through a central lobby by stairs and elevators.

Figure 3.5 represents a notional space summary for a two-story configuration. Local missions may require variance.

ARRIVING PASSENGER AREAS - LOWER LEVEL	16,600
Arrival Gate	12,000
Restrooms	500
Immigration Station	100
Baggage Claim	3,000
Customs/Agriculture Counter	500
Passenger Support Conveniences	TBD
Baggage Claim Exit	500
ADMINISTRATIVE AREAS	5,000
<u>Administrative Offices</u>	5,000
<ul style="list-style-type: none"> <li>TMO/CTO</li> <li>Terminal Management</li> <li>Supervisor/Funds</li> <li>Dispatch</li> <li>Lost and Found</li> <li>Customs/Agriculture/Immigration</li> <li>Break Room</li> <li>Storage</li> </ul>	
<u>Optional</u>	TBD
<ul style="list-style-type: none"> <li>Conference/Training</li> <li>Army, Navy, Marine Liaisons</li> <li>Red Cross</li> </ul>	
AIRCRAFT SUPPORT AREAS	7,000
Baggage Screening/Build-up	3,000
Baggage Break-down	3,000
Clean Fleet	1,000
BUILDING SUPPORT AREAS	8,200
Custodial Services	200
Mechanical Room	4,000
Electrical Room	3,000
Communications	1,000
TOTAL NET AREA (in square feet)	82,500
TOTAL GROSS AREA (Total Net Area * 1.15) based on an 85% efficiency factor, (in square feet)	94,875

Figure 3.5 Notional Space Summary for a Type IV Large Terminal

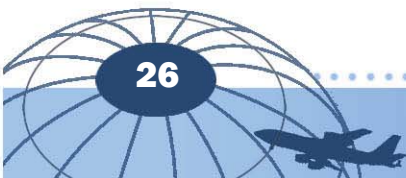

Upper Level

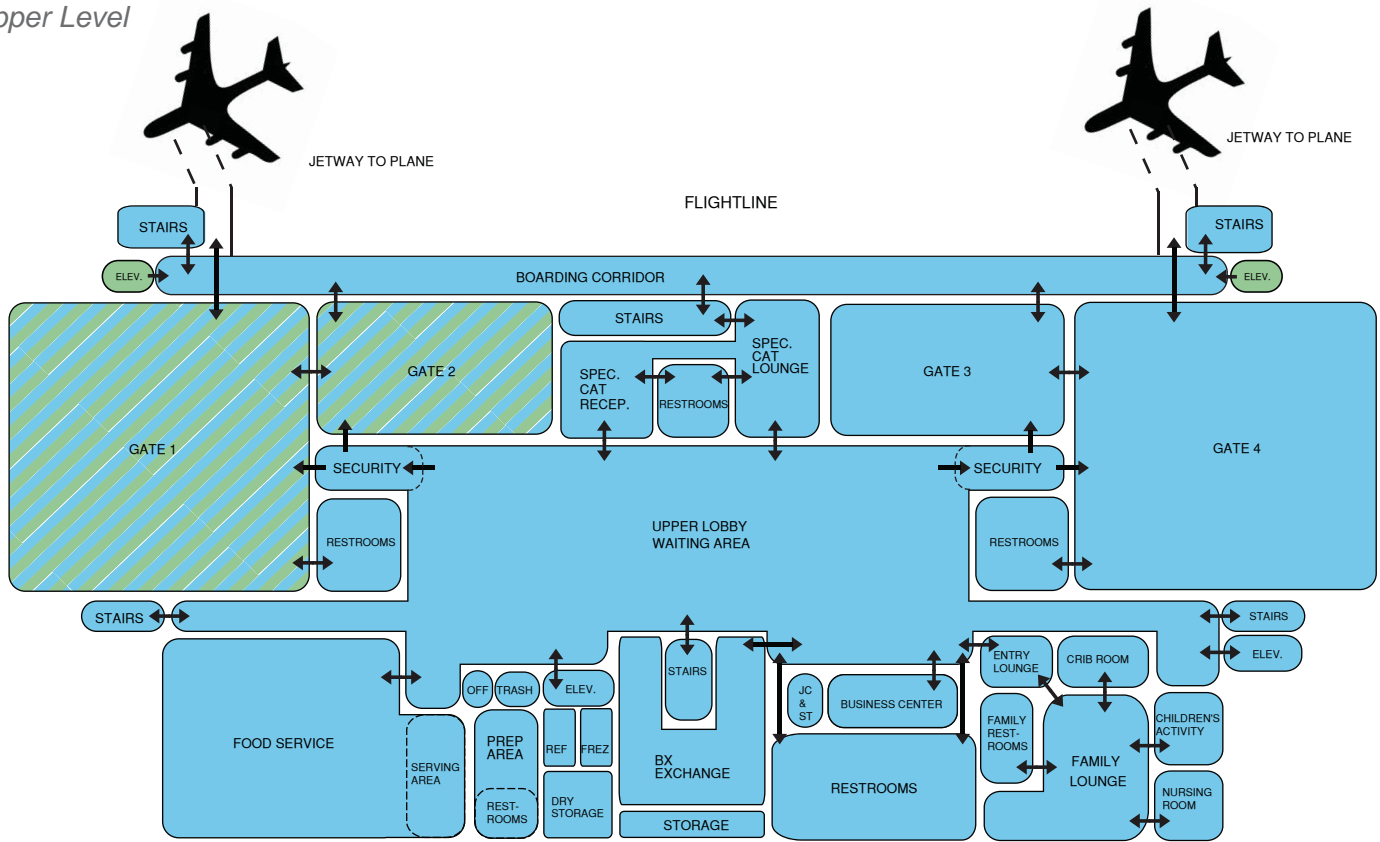

Lower Level

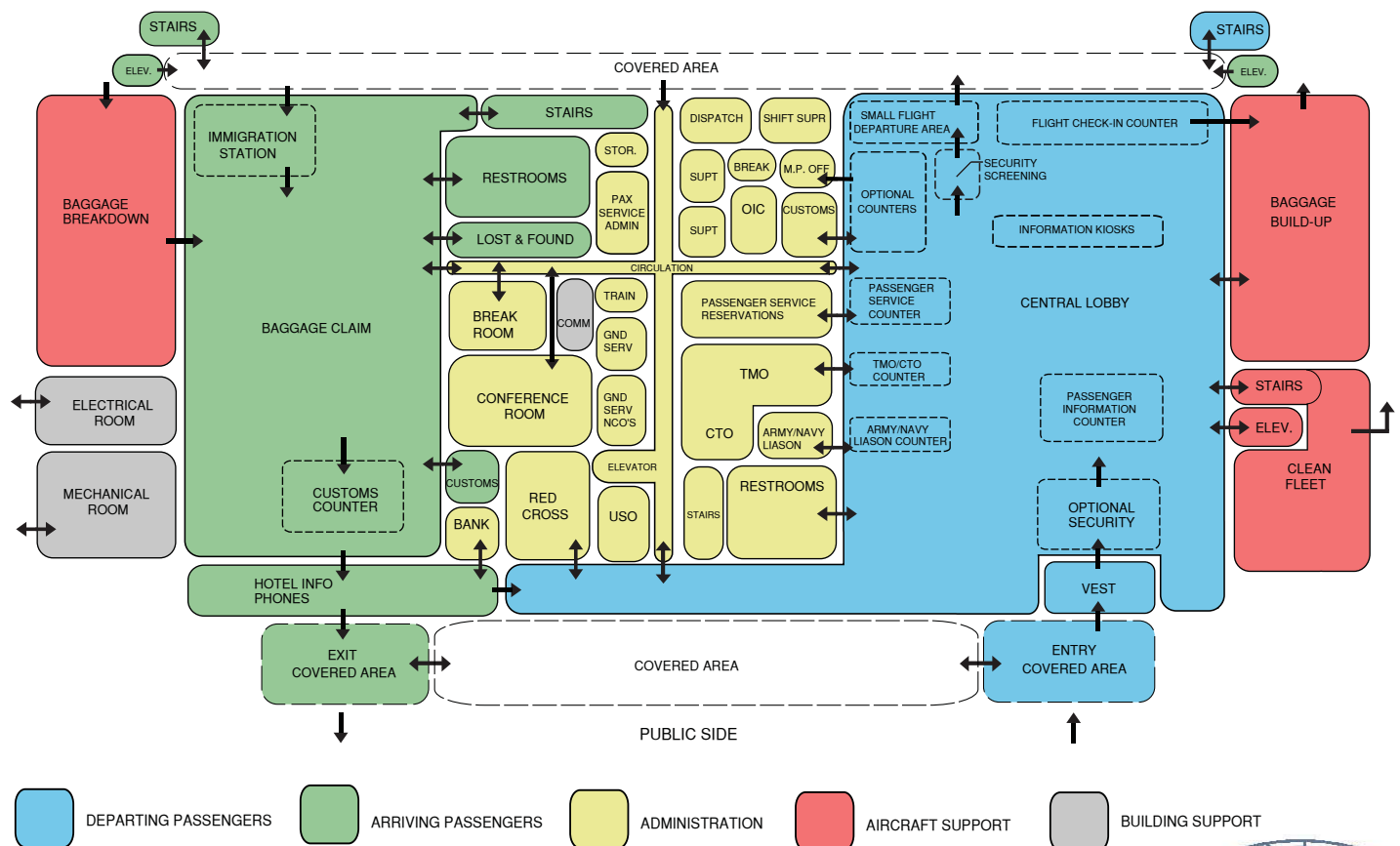

Figure 3.6 Flow and Adjacency Diagram for a Type IV Large Terminal

## Medium - Type II Passenger Terminal

The floor plan serves a mix of military and occasional commercial aircraft. The terminal consists of only one level; passengers use shuttle or walk between the aircraft and the terminal Reference Figure 3.8 for Flow and Adjacency Diagram.

Place Arriving Passenger Area on one side of the terminal, and Departing Passenger Gate Area on the

opposite side. Separate Baggage Build-Up/Break-Down areas to distinguish arriving and departing baggage minimizing conflict between baggage handling vehicles.

Figure 3.7 represents a notional space summary for a one-story configuration. Local missions may require variance.

<b>DEPARTING PASSENGER AREAS</b>	<b>15,400</b>
Entry Vestibule	200
Central Lobby	5,000
Passenger Support Conveniences	TBD
Passenger Service Kiosks	100
<u>Service Counters</u>	500
<ul style="list-style-type: none"> <li>• Passenger Service</li> <li>• TMO/CTO</li> <li>• Information</li> <li>• Flight Check-In</li> </ul>	
<u>Optional Counters</u>	TBD
<ul style="list-style-type: none"> <li>• Red Cross</li> <li>• Rental Car</li> <li>• Army, Navy, Marine Liaisons</li> </ul>	
Special Category Lounge	1,000
Family Lounge	800
Vending/Phones/ATM	300
Business Center	200
Restrooms	300
Security Queue	1,000
Security Screening	500
Passenger Gate Corridor	500
<u>Departing Passenger Gate Area</u>	5,000
<ul style="list-style-type: none"> <li>• 2 Departure Gates</li> <li>• Passenger Agent Counters</li> <li>• Passenger Seating Area</li> <li>• Vending</li> </ul>	
<b>ARRIVING PASSENGER AREAS</b>	<b>7,550</b>
Arrival Gate	5,000
Restrooms	500
Immigration Station	50
Baggage Claim	1,200
Customs/Agriculture Counter	300
Passenger Support Conveniences	TBD
Baggage Claim Exit	500

<b>ADMINISTRATIVE AREAS</b>	<b>5,000</b>
<u>Administrative Offices</u>	5,000
<ul style="list-style-type: none"> <li>• TMO/CTO</li> <li>• Terminal Management</li> <li>• Supervisor/Funds</li> <li>• Dispatch</li> <li>• Lost and Found</li> <li>• Customs/Agriculture/Immigration</li> <li>• Break Room</li> <li>• Storage</li> </ul>	
<u>Optional</u>	TBD
<ul style="list-style-type: none"> <li>• Conference/Training</li> <li>• Army, Navy, Marine Liaisons</li> <li>• Red Cross</li> </ul>	
<b>AIRCRAFT SUPPORT AREAS</b>	<b>5,000</b>
Baggage Screening/Build-up	2,000
Baggage Break-down	2,000
Clean Fleet	1,000
<b>BUILDING SUPPORT AREAS</b>	<b>4,500</b>
Custodial Services	
Mechanical Room	2,000
Electrical Room	500
Communications	2,000
<b>TOTAL NET AREA (in square feet)</b>	<b>37,450</b>
<b>TOTAL GROSS AREA (Total Net Area * 1.15) based on an 85% efficiency factor, (in square feet)</b>	<b>43,067</b>

Figure 3.7 Notional Space Summary for a Type II Medium Terminal

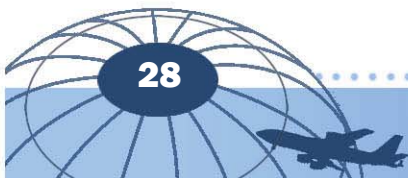

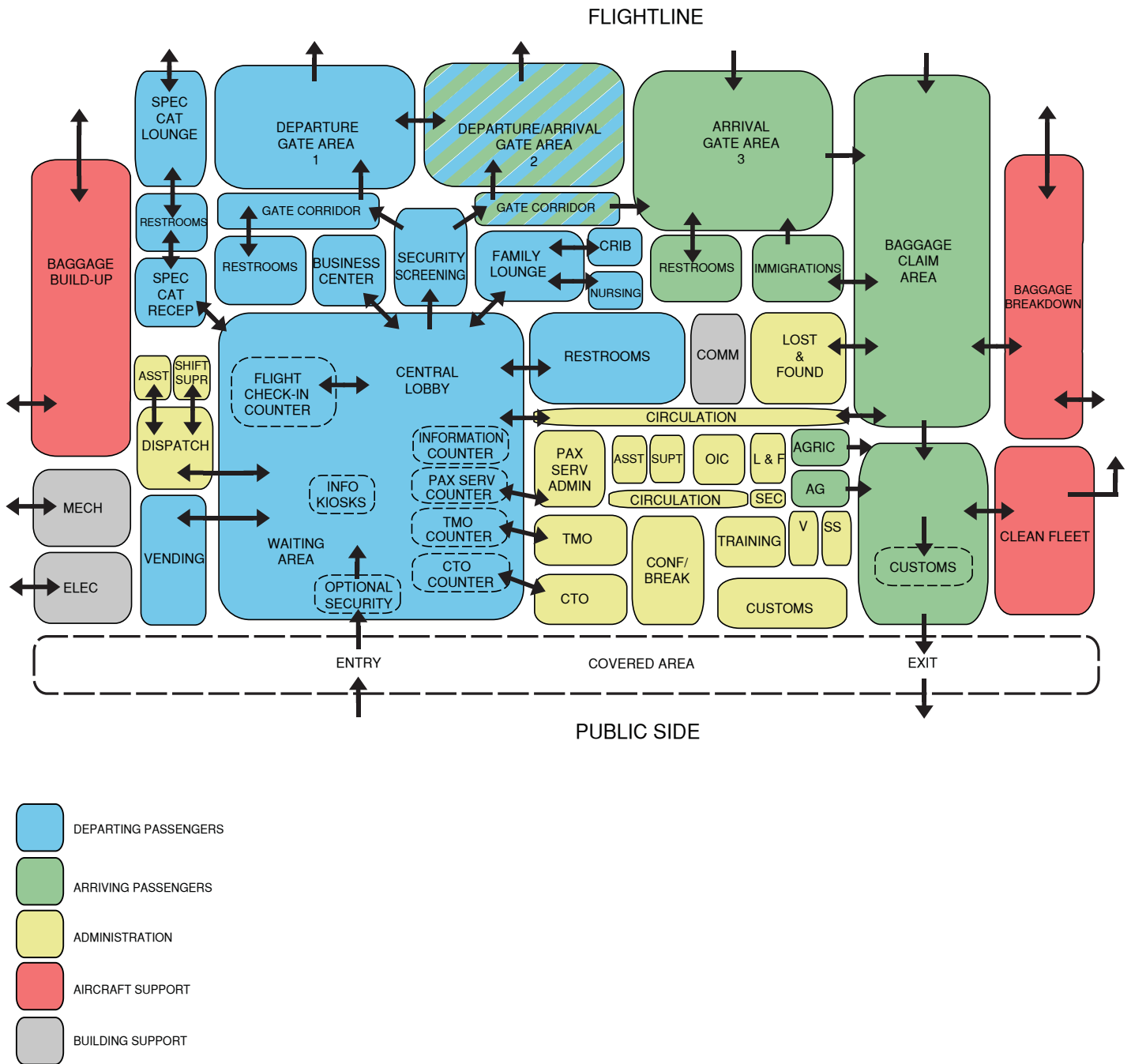

Figure 3.8 Flow and Adjacency Diagram for a Type II Medium Terminal

### Small - Type IB Passenger Terminal

The Small floor plan layout is the result of a reduced staff, requiring passenger processing functions to be located in close proximity to one another. Staff move from one process to another. Place passenger processing, Flight Check-in, Baggage Build-Up and Break-Down, and administrative offices on one side of the terminal. Locate all other passenger service functions (vending, restrooms, Family Lounge, and Special Category Lounge) on the opposite side of the main lobby to reduce conflict between spaces and processing functions. Reference Figure 3.10 for Flow and Adjacency Diagrams.

The small facility size and the variety of aircraft require “multi-purpose” use of both the Central Lobby and Gates. Use Arrival and Departure Gate areas in conjunction with one another to accommodate larger passenger loads. For sudden surges of passengers, use small terminal gate areas as waiting areas.

Figure 3.9 represents a notional space summary for a Type IB Small Terminal one-story configuration. Local missions may require variance.

<b>DEPARTING PASSENGER AREAS</b>	<b>8,150</b>
Entry Vestibule	200
Central Lobby	2,500
Passenger Support Conveniences	TBD
Passenger Service Kiosks	50
<u>Shared Service Counter</u>	200
<ul style="list-style-type: none"> <li>• Passenger Service</li> <li>• TMO/CTO</li> <li>• Information</li> <li>• Flight Check-In</li> </ul>	
Special Category Lounge	400
Family Lounge	350
Vending/Phones/ATM	150
Restrooms	300
Security Queue	500
Security Screening	500
Passenger Gate Corridor	500
<u>Departing Passenger Gate Area</u>	2,500
<ul style="list-style-type: none"> <li>• 1 Departure/Arrival Gate</li> <li>• Passenger Agent Counter</li> <li>• Passenger Seating Area</li> <li>• Vending</li> </ul>	
<b>ARRIVING PASSENGER AREAS</b>	<b>2,400</b>
Arrival Gate (sometimes combined with Departure Gate)	1,300
Baggage Claim	600
Passenger Support Conveniences	TBD
Baggage Claim Exit	500

<b>ADMINISTRATIVE AREAS</b>	<b>1,000</b>
<u>Shared Administrative Offices</u>	1,000
<ul style="list-style-type: none"> <li>• TMO/CTO</li> <li>• Terminal Management</li> <li>• Supervisor/Funds</li> <li>• Dispatch</li> <li>• Lost and Found</li> <li>• Break Room</li> <li>• Storage</li> </ul>	
<b>AIRCRAFT SUPPORT AREAS</b>	<b>1,500</b>
Baggage Screening/Build-up/Break-down	1,000
Clean Fleet	500
<b>BUILDING SUPPORT AREAS</b>	<b>550</b>
Custodial Services	
Mechanical Room	400
Electrical Room	100
Communications	50
<b>TOTAL NET AREA (in square feet)</b>	<b>13,600</b>
<b>TOTAL GROSS AREA (Total Net Area * 1.15) based on an 85% efficiency factor, (in square feet)</b>	<b>15,640</b>

Figure 3.9 Notional Space Summary for a Type IB Small Terminal

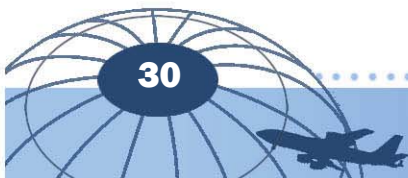

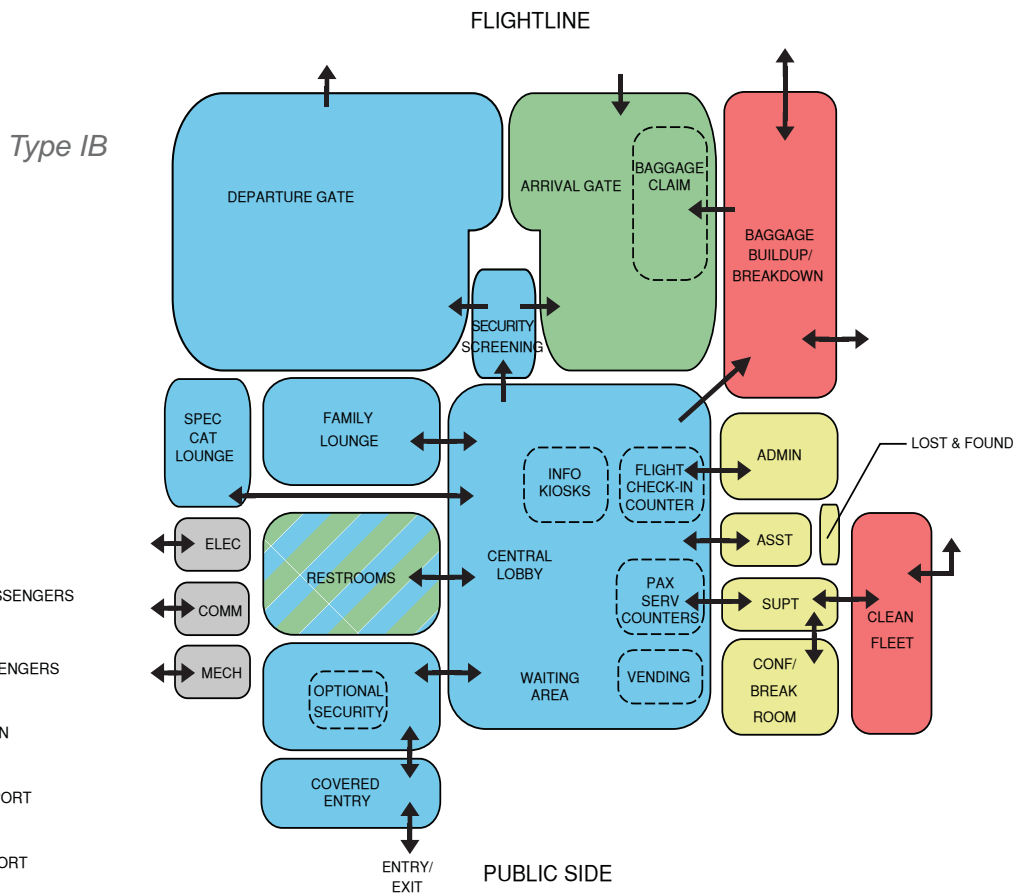
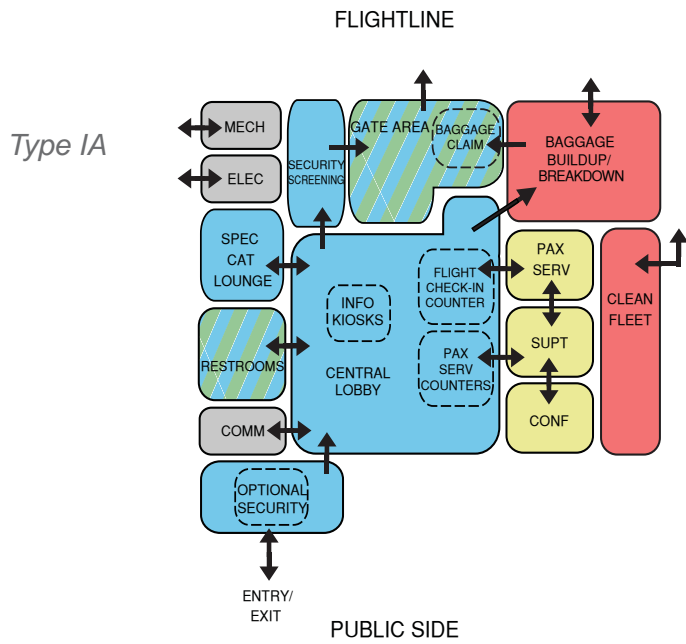

- DEPARTING PASSENGERS
- ARRIVING PASSENGERS
- ADMINISTRATION
- AIRCRAFT SUPPORT
- BUILDING SUPPORT

Figure 3.10 Flow and Adjacency Diagrams for Type IA and Type IB Small Terminals



## 3.9 Building Systems

This subsection addresses, in general terms, building construction materials, components, and assemblies, as well as mechanical, electrical, and security systems. Determine specific requirements at the local level. Comply with International Building Code (IBC), local building codes, standards, and other AF and DoD regional requirements.

### A. Building Construction

In general, select building materials that are economical, locally available, and resilient in the local environment. Use construction assemblies and techniques that are customary in the local community.

### B. Doors

Provide large, automatic doors to accommodate passengers with baggage at entries and one-way exits. Use cypher locked doors, or similar devices, at service entries and gates. Provide oversized doors in service/baggage areas to facilitate movement of baggage transport vehicles or pallets to and from the aircraft. Reference Chapter 3, Section J for facility security requirements.

### C. Windows

Liberal use of glazing is encouraged in building design. Balance aesthetic qualities with the need for security and force protection. Daylighting in all gathering areas is recommended to enhance passenger comfort.

### D. Elevators

To facilitate the movement of passengers in multi-story/large terminals, locate elevators adjacent to the Central Lobby.

### E. Heating, Ventilation, and Air Conditioning

Provide temperature sensors with remote adjustment or tamper-proof thermostats. Provide zone controls for maintaining different environmental conditions in different functional areas so that operating systems in parts of the terminal can be reduced during down times.

### F. Plumbing

In addition to the standard codes, provide adequate drinking fountains throughout the terminal including the Exterior Activity Area. If required, provide eye-wash stations and emergency showers in accordance with Occupational Safety and Health Administration (OSHA) standards.

### G. Lighting

Provide fluorescent lighting with low temperature, energy-efficient ballasts and lamps. Include task lighting at office desks in administrative areas. Include motion detection switches for administrative spaces. Wherever natural light is available, provide lighting control systems, including ambient light dimmers, to automatically reduce intensity levels of artificial lighting.

Use high-intensity discharge light sources controlled by automatic timers to provide exterior lighting of parking areas and walkways. Locate exterior lighting fixtures in parking lots and pedestrian walkways.

### H. Flight Information/Public Address

Provide flight information in the following visible locations:

- Central Lobby Information Counter
- Departure Gate Area
- Food Service Area

Provide one channel in the Special Category Lounge with flight information. Include a hands-free, two-way intercom/public address system throughout the facility.

Locate the Central Intercom Console in the Administrative Area. Provide for the isolation of each area served so the public address system can be turned off in individual lounges and gates.

Provide a centrally operated music system to serve all passenger areas. Provide differential controls for each space served.



## I. Telephone, Data, and Communications

Provide telephone and computer wiring to support voice, data, and television. Equip the facility with the capability for intercom, cable television, defense systems network (DSN), global information network system (GINS), on-base lines, and local area network (LAN) connections.

“Wi-Fi” - Provide in all areas of the terminal for passenger convenience.

**Media Devices** - In public waiting areas, provide additional electrical capacity for charging of personal digital devices such as cell phones, laptops, and tablets. This can be in the form of charging stations, integrated outlets in gang seating, or extra wall outlets adjacent to seating.



*Examples of a Charging Station and Integrated Outlets in Gang Seating*

Confirm specific communications requirements with the Communications Squadron before planning major building upgrades or modifications.

## J. Security Systems and Equipment

Security levels at Passenger Terminals vary depending on location and country. The location of security points may change within a single terminal due to facility or operational requirements. Physical security measures must be included for both the terminal building and the surrounding site (e.g., parking lots, roads, and cargo areas) when adjacent to or collocated with the Passenger Terminal.

**Closed Circuit Television** - Incorporate security surveillance cameras into the design of the queuing and security checkpoint areas and throughout the terminal in general. Monitor each interior open waiting area either from an adjacent Service Counter or by video camera.

**Intrusion Detection** - Install an Intrusion Detection Alarm System for all terminals. Locate alarms at all major entrances and exits, including all gate locations.

**Duress Alarms** - Provide Duress Alarms at various counter locations, Supervisor/Funds Room, and Gate areas. Coordinate installation and monitoring with local security forces.

**Door Security** - Install cypher locks on service doors and Supervisor/Funds Room (with an additional interior dead bolt).

**X-Ray and Magnetometer Equipment** - Provide equipment at the Security Screening Area; determine the number of units needed based on local requirements and anticipated passenger loads. Select equipment based on Air Force requirements. Ensure large pieces of baggage and parcels can be efficiently examined.



*X-Ray and Magnetometer Equipment for Security Screening*



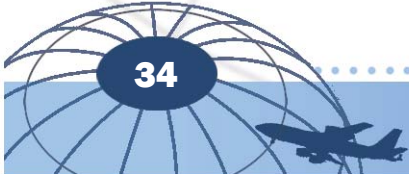
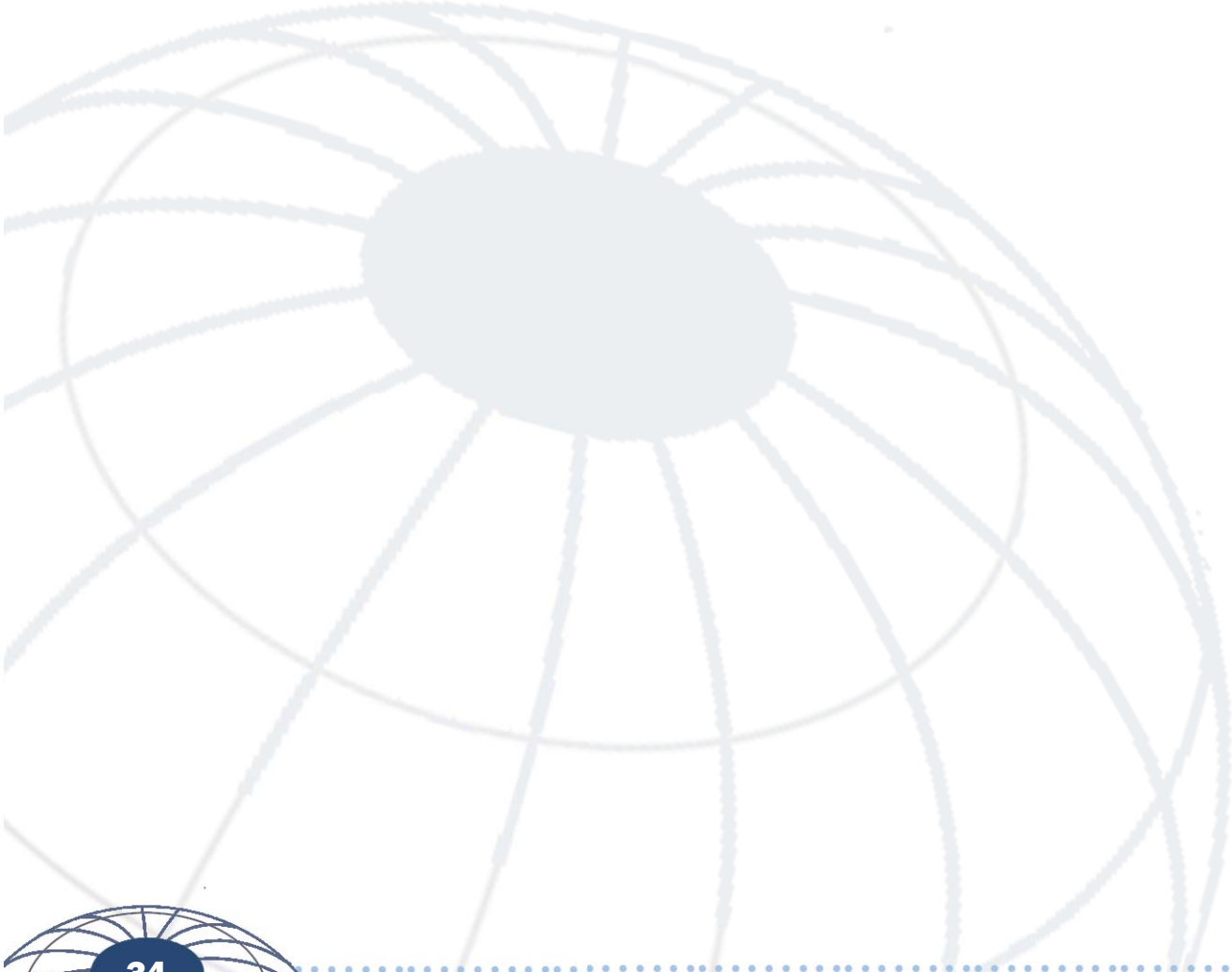

# Chapter 4 – Interior Standards

## 4.1 Summary

A quality Passenger Terminal provides an environment that promotes customer satisfaction and comfort, conveys professionalism, improves job performance, and maintains security.

This chapter addresses interior finish standards, color concepts, and general criteria to assist in creating a standard of understated excellence. Appendix One includes two recommended color schemes for the terminal. Appendix Two includes five mandatory color schemes for Family Lounges.

## 4.2. General Design Criteria

Consider the following guidelines when designing an interior scheme for a terminal. Designs shall be visually interesting and reflect the following:

- Regional character and/or base architectural theme
- Timeless design
- A holistic approach to exteriors and interiors
- Function and character with appropriate volumes
- An open layout with clear visibility to functional areas
- Clear way-finding
- Efficient circulation flow

## 4.3 Comprehensive Interior Design (CID)

CIDs ensure that both new and renovation projects match the design objectives for the entire terminal. Use this approach for all new construction, significant interior renovations, and special focus areas. The CID package addresses:

- Interior finishes
- Furnishings
- Signage
- Accessories/Artwork

Reference the AMC “Interior Design Guide” for an expanded general discussion of interior design requirements and Appendix One and Appendix Two for interior color schemes.

## 4.4 Interior Finishes

Incorporate finishes that are aesthetically pleasing, coordinated, durable, and easily maintained. Reference Figure 4.1 for Approved Interior Finishes Schedule.

### A. Color Concepts

Choose a warm or a cool color scheme from Appendix One to integrate all areas of terminal interiors.

Incorporate accent colors in carpets and/or carpet borders, upholstery, accessories, and artwork. Use accent colors sparingly to complement neutral background colors. Select neutral tones for materials that cover large spaces: paint, hard-surface flooring, and system furniture wall panels. Color selections must be compatible with the blue tricolor AMC Passenger Service Logo.



*Central Lobby*

### B. Floors

Use durable and appropriate floor materials in high traffic areas and Food Preparation Areas, such as terrazzo tile, quarry tile, or ceramic tile.

Provide patterned carpet tile in seating areas, offices, conference, and training areas. Use broadloom carpet in special use spaces such as the Special Category Lounges. Consider multicolored, patterned carpet tile in darker shades in the public areas.



APPROVED INTERIOR FINISHES	FLOORS							BASE		WALLS			CEILING		TRIMS		NOTES						
	Natural Stone	Terrazzo Tile	Carpet Tile	Broadloom Carpet	Sheet Vinyl	Vinyl Composition Tile	Ceramic Tile	Sealed Concrete	Slip / Chemical Resistant Coating	Vinyl Resilient	Ceramic Tile	Natural Stone	Wood	Painted Gypsum Board	Vinyl Wallcovering	Painted Concrete Block		Ceramic Tile	Acoustical Ceiling Tile	Painted Gypsum Board	Painted Exposed Structure	Wood Chair Rail	Heavy Duty Chair Rail
<b>DEPARTING PASSENGER AREAS</b>																							
Entry Vestibule	•	•				•	•			•	•	•		•	•			•	•	•		•	
Central Lobby	•	•				•	•			•	•	•		•	•			•	•	•		•	
Special Category Lounge																							
• Lounge				•						•		•		•	•			•	•			•	
• Restroom	•						•			•	•	•		•	•		•	•					
Family Lounge																							
• Lounge					•					•				•	•			•	•				•
• Restroom							•			•	•			•	•		•	•					
Vending / Phones / ATM	•	•				•	•			•	•	•		•				•	•	•			•
Food Service																							
• Kitchen and Serving Line		•				•	•			•	•			•			•	•					
• Dining	•	•				•	•			•	•	•		•	•			•	•				•
Business Center	•	•	•				•			•				•	•			•	•				
Passenger Gate Corridor																							
Departing Passenger Gate Area		•	•		•					•				•	•			•	•				•
Gift Shop and Base Exchange Annex	•	•				•	•			•	•	•		•				•	•				
Boarding Corridor																							
<b>ARRIVING PASSENGER AREAS</b>																							
Arrival Gate	•	•				•				•	•	•		•	•			•	•	•		•	
Baggage Claim	•	•				•				•	•	•		•	•			•	•	•		•	
Baggage Claim Exit	•	•				•				•	•	•		•	•			•	•	•		•	
<b>ADMINISTRATIVE AREAS</b>																							
Administrative Offices		•	•							•				•				•					
Break Room	•	•				•	•			•	•	•		•				•					
Conference/Training Room				•						•				•	•			•				•	
Office Storage		•	•							•				•				•					
Corridors		•	•							•				•				•					
<b>AIRCRAFT SUPPORT AREAS</b>																							
Baggage Screening / Build-Up					•			•	•						•				•				
Baggage Break-Down					•			•	•						•				•				
Clean Fleet					•			•	•						•				•				
<b>BUILDING SUPPORT AREAS</b>																							
Restrooms	•					•				•	•			•				•					
Custodial Services					•			•	•	•					•								2
Mechanical Room					•			•							•				•				
Electrical Room					•			•							•				•				
Communications					•			•							•				•				
<b>Notes:</b>																							
1. Passenger Service Counters, Optional Counters, and Flight Check-In should be finished similar to the surrounding space.																							
2. Includes all janitor closets, storage areas, and custodial storage areas.																							

Figure 4.1 Approved Interior Finishes Schedule

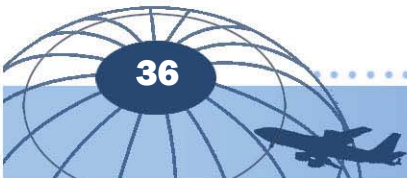

### C. Walls

Options such as vinyl wall coverings, acoustical wall coverings, ceramic tile, paint, and textured paint finishes on interior walls are all acceptable.

Use ceramic wall tile in restrooms for ease of maintenance. Where required, include chair rails to protect walls and wall coverings from furniture, carts, hand wheeled luggage, and mobility bags.

### D. Ceilings

Use 2 ft. x 2 ft. acoustical ceiling tile throughout the major areas of the terminal. Tiles with concealed grid or revealed edge are preferred. In restrooms and other wet areas use a water-resistant gypsum board or plaster with water resistant paint finishes.



*Terminal Ceiling Detail*

### E. Window Coverings

Use vertical blinds, horizontal blinds, and/or mechanized sun shades in public spaces and office areas to filter daylight but still allow outdoor views. Use lined draperies in the Special Category Lounges and draperies with blackout lining in the Conference/Training Room to block out light for visual presentations.

## 4.5 Furnishings

Furnishings are an integral part of the comprehensive building design and image. Coordinate furnishing selections with facility materials, textures, and colors.

### A. Offices

Design office areas with either panel-hung or desk-based systems furniture. These products generally require less floor space than free-standing furniture and also allow for future reconfiguration. Select furniture that has integral conduits, raceways, or channels for electrical and communications service to hide unsightly wires and cables. Use

sound absorbent fabric panels and/or privacy screens to reduce background noise; use plastic-laminate work surfaces.

Use systems furniture in staff offices occupied by four or more persons. Integrate systems and free-standing furniture during Interior Design Development. Systems furniture includes interchangeable wall panels, panel hung desks, and storage modules that can be combined to form office workstations. These stations allow for the easy integration of computer hardware in office areas that use systems furniture.

### B. Waiting Areas

Use gang seating in public waiting areas. Provide a minimum inside seat width of 18-inches and arms for every seat. Use metal arms and legs (as opposed to wood) for durability and ease of maintenance. Use high quality, breathable vinyl or heavy-duty upholstery fabric. When purchasing new chairs or replacement furniture include the embossed AMC logo. Reference Section 3.9 H for additional seating information.



*Seating with Embossed AMC Logo*

### C. Lounges

Provide high quality, durable furniture for the Special Category Lounge that is comparable to executive offices. In Family Lounges, chose durable and washable cribs, changing tables, and rockers in materials and colors that coordinate with the chosen Family Room interior color scheme.

Reference Appendix Two for approved Family Room color schemes.



## E. Accessories

Professionally framed artwork, wall murals, and live or high-quality silk plants complement the interior finishes and reinforce the design scheme. Provide trash and recycling receptacles that coordinate with the color scheme.

### 4.6 Signage

Develop an integrated, interior sign plan as part of the comprehensive interior design scheme throughout the terminal. Use professionally made signs that are appropriately sized for the viewing distance and compatible with the facility design scheme.

Include mandatory AMC Passenger Logo behind AMC operated counters as shown in Figure 4.2.

Coordinate with the following publications for further sign guidance:

- AMCI 24-101, Volume 14 for additional information on antiterrorism and access control signage
- AFP 32-1097, Air Force Sign Standards

Keep instructional messages to passengers to a minimum and post only where necessary using electronic messaging boards.

Put temporary notices, memos, employee information, etc., on framed commercial bulletin boards located away from public view. Do not use hand-lettered or stenciled signs in any room.



Seating in Terminal Central Lobby

### 4.7 Service Counters

Drawings in Appendix Three provide general plans, elevations, and detail information for the Passenger Service Counters, Flight Check-In Counters, Secondary Writing Counter and Workstation. Design other service counters to a similar standard and architectural theme.

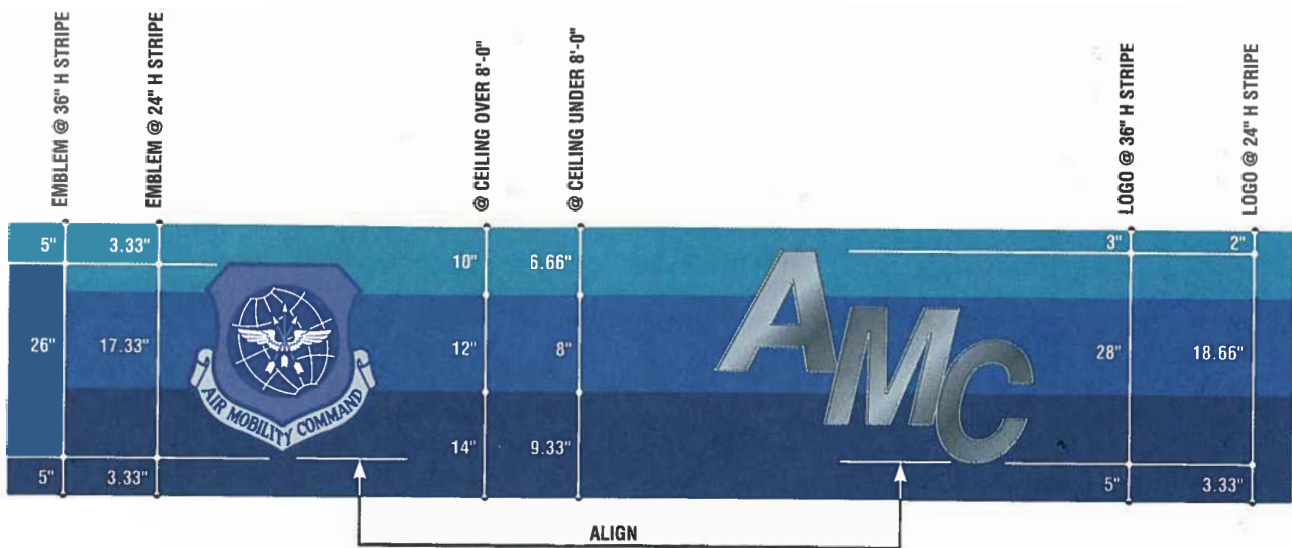
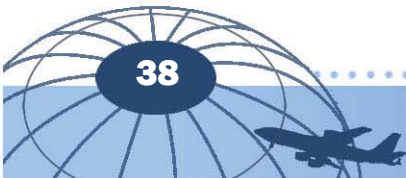

Figure 4.2 AMC Passenger Service Logo



**U.S. Customs Counter** - Drawings in Appendix Three, A3.3, provide plan, elevations, and detail information specifically for the U.S. Customs counters as referenced in the “U.S. Customs Service Technical Standards for Passenger processing at Airports”. Use the most current standards; however, coordinate the final counter design with the local U.S. Customs Representative. Unique features for this counter include surfacing inspection tables with stainless steel instead of the standard counter material.



*US Customs Counter*

#### **4.8 Miscellaneous**

Coordinate the color of fire bells, electrical boxes, and other protrusions to match adjacent walls. Coordinate light switches, receptacles, and their covers with the walls in which they are located. When providing color contrast to comply with ABA requirements for safe way finding, use colors that coordinate with the overall scheme.

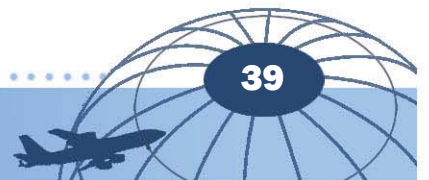

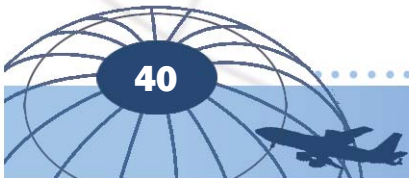
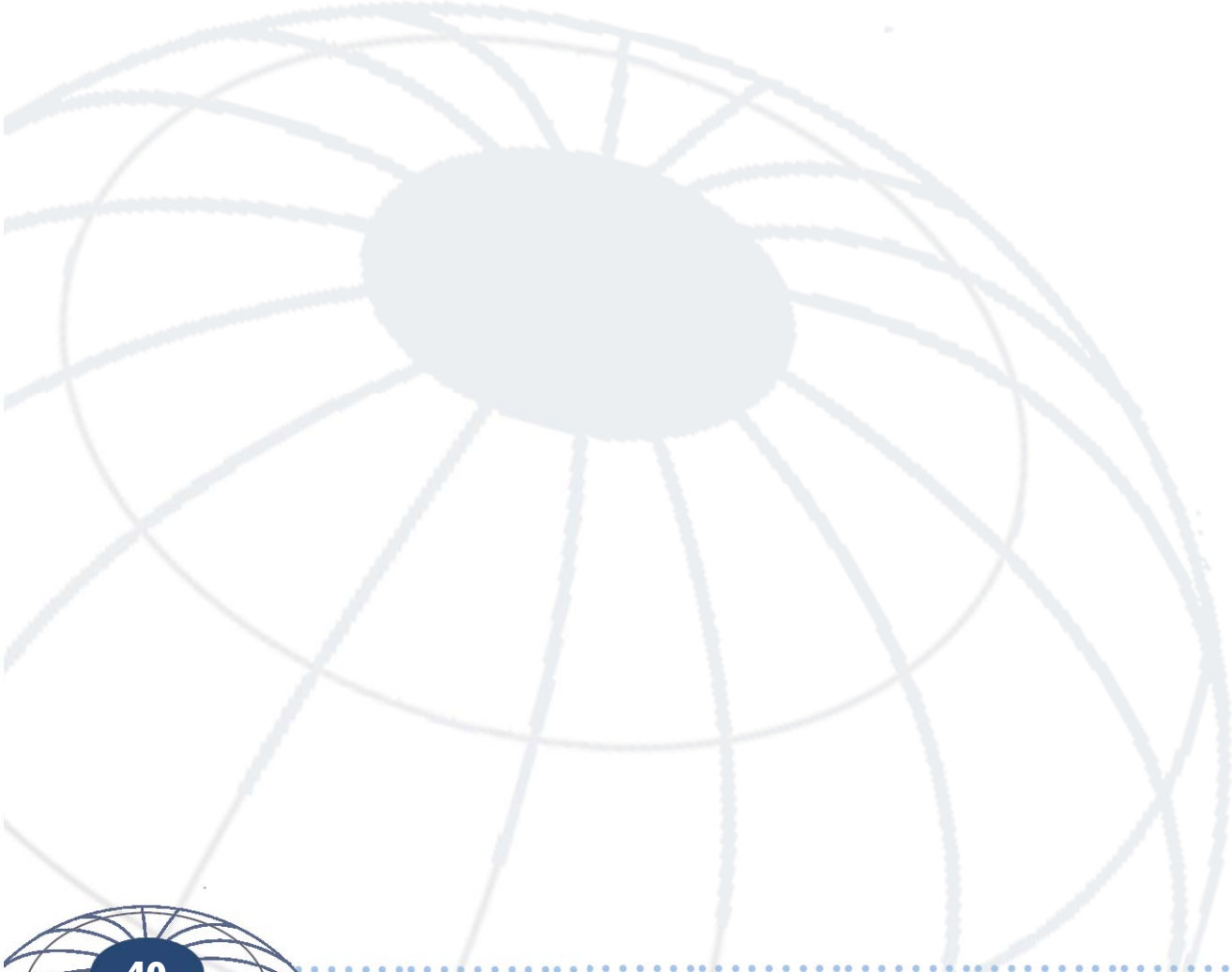



# Appendices

## Appendix One

Terminal Color Boards - Cool and Warm Schemes

## Appendix Two

Family Lounge Color Boards - Five Schemes

## Appendix Three

Service Counter Drawings

## Appendix Four

Notional Terminal Floor Plans (Large, Medium, and Small)

## Appendix Five

General References

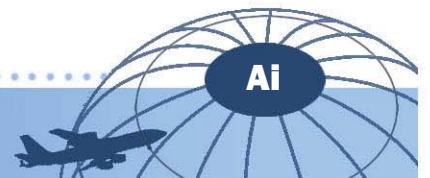

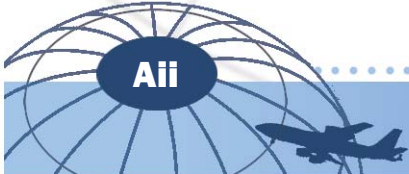
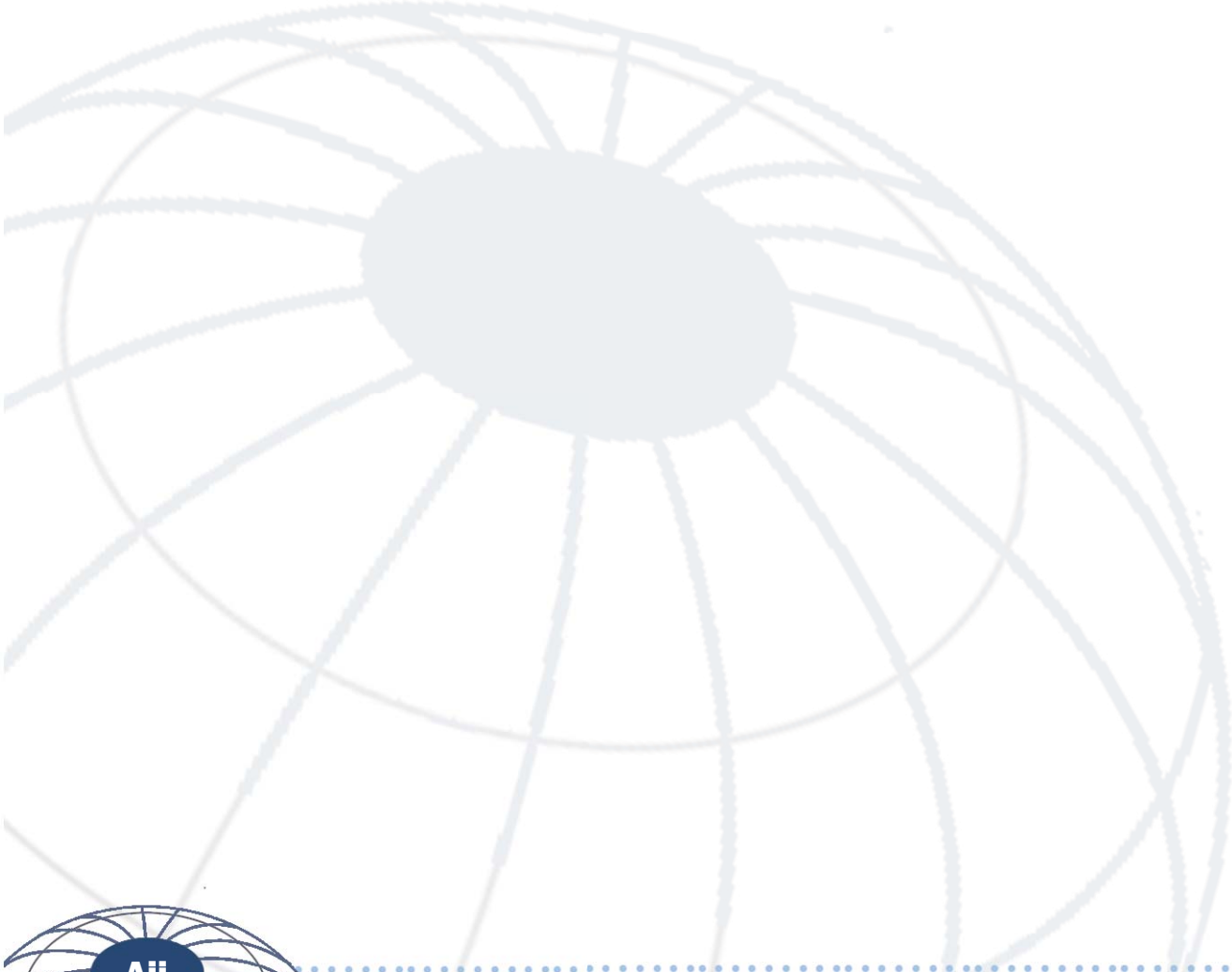

# APPENDIX ONE - TERMINAL COLOR BOARDS (COOL COLOR SCHEME)

Paint



Acoustical Ceiling Tile



Carpet Tile



Quarry Tile



Sheet Vinyl



Vinyl Composition Tile



Stained Concrete



Terrazzo Tile



Terrazzo Tile

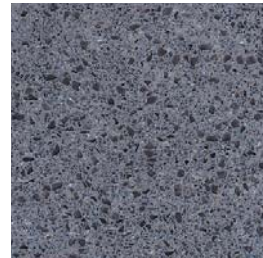

Terrazzo Tile

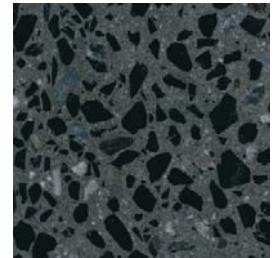

Wall Coverings



Restrooms:  
Ceramic Wall Tile



Restrooms:  
Ceramic Wall Tile



Restrooms:  
Ceramic Floor Tile



Natural Stone



Solid Surface

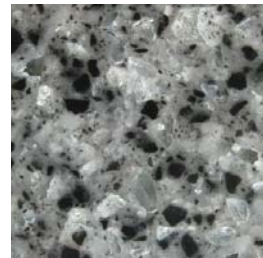

Plastic Laminate



## APPENDIX ONE - TERMINAL COLOR BOARDS (COOL COLOR SCHEME)

### PAINT



---

	Manufacturer: Benjamin Moore Color: White Dove* Color #: OC-17
	Manufacturer: Benjamin Moore Color: Revere Pewter* Color #: HC-172
	Manufacturer: Benjamin Moore Color: Coventry Gray* Color #: HC-169
	Manufacturer: Benjamin Moore Color: Chelsea Gray* Color #: HC-168

\* Option - color as shown available in a textured paint finish, Manufacturer: Scuffmasters, Series: Armor

### PAINT - AMC LOGO

---

	Manufacturer: Benjamin Moore Color: Blue Marguerite Color #: 2063-50
	Manufacturer: Benjamin Moore Color: Brilliant Blue Color #: 2065-30
	Manufacturer: Benjamin Moore Color: Blue Color #: 2066-10



# APPENDIX ONE - TERMINAL COLOR BOARDS (COOL COLOR SCHEME)

## WALL COVERINGS

### Primary 1

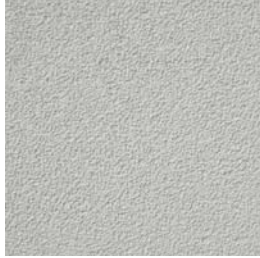

Manufacturer: Source One Exclusive  
Collection: Steppe  
Color: Cement  
Color #: 2VST-44

### Accent 1

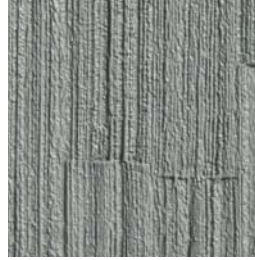

Manufacturer: Versa  
Collection: Bataan  
Color: Luzon  
Color #: ASL 92533

### Accent 2



Manufacturer: Source One Exclusive  
Collection: Montage  
Color: Espresso  
Color #: 2VMT-18

### Acoustical 1



Manufacturer: MDC Wall coverings  
Collection: Acoustical Resource  
Pattern: Stratford Crush  
Color: Sparkling Spring  
Pattern #: RSC-2006

### Acoustical 2



Manufacturer: MDC Wall coverings  
Collection: Acoustical Resource  
Pattern: Stratford Crush  
Color: Smoke Stack  
Pattern #: RSC-2036

### Restrooms



Manufacturer: Len-Tex  
Collection: Coronado  
Color: Monterey  
Pattern #: 3621-CR

## ACOUSTICAL CEILING TILE



Manufacturer: USG  
Series: Mars Climaplus  
Item #: 86985  
2' x 2'

## HEAVY DUTY HAND RAIL



Manufacturer: InPro Corp.  
Collection: 3500MV  
Color: Natural Maple 0531

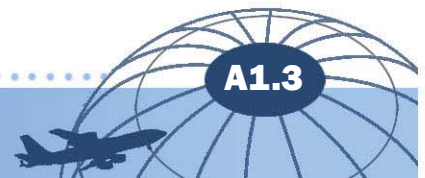

## APPENDIX ONE - TERMINAL COLOR BOARDS (COOL COLOR SCHEME)

### CARPET TILE & RUBBER BASE



#### CARPET

Manufacturer: Bigelow  
Collection: First One Up Modular  
Color: 7979 Alluvial  
Installation: Monolithic



#### RUBBER BASE

Manufacturer: Roppe  
Color: Black Brown  
Color #: 193

### TERRAZZO TILE

#### Primary



#### TILE:

Manufacturer: Daltile  
Series: Atmosphere  
Color: TZ58 - Infinity (Fine Grain)

#### GROUT:

Manufacturer: Mapei  
Color: 27 Silver

#### Accent 1

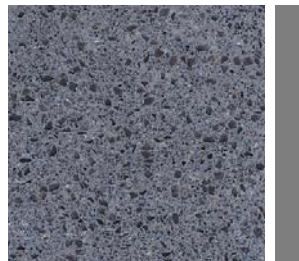

#### TILE:

Manufacturer: Daltile  
Series: Atmosphere  
Color: TZ61 - Mystical  
(Crystal Grain)

#### GROUT:

Manufacturer: Mapei  
Color: 19 Pearl Gray

#### Accent 2

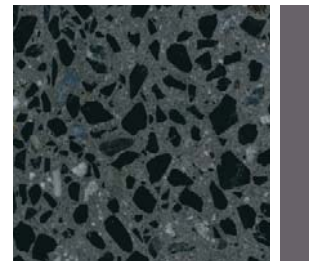

#### TILE:

Manufacturer: Daltile  
Series: Micro  
Color: TZ17 - Black of Night

#### GROUT:

Manufacturer: Custom  
Building Products  
Color: 19 Pewter

### STAINED CONCRETE



Manufacturer: Concrete Earth  
Collection: Ocera Stain Series  
Style: Opus  
Color: Granite

### QUARRY TILE



Manufacturer: American Olean  
Collection: Quarry Naturals  
Color: Shadow Gray N46  
(with abrasive grain)



## APPENDIX ONE - TERMINAL COLOR BOARDS (COOL COLOR SCHEME)

### VINYL FLOORING



Manufacturer: Johnsonite  
Collection: Acczent Finishes  
Color: Maple  
Color #: 3005  
Style: Sheet Vinyl



Manufacturer: Azrock  
Series: Cortina Grande  
Color: Loam  
Color #: CG403  
Style: 16" x 16" Solid Vinyl Tile

### CERAMIC TILE

#### Floor

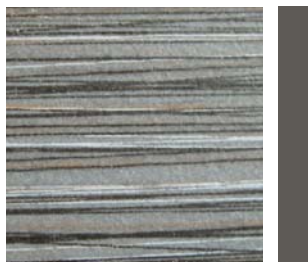

**TILE:**  
Manufacturer: Daltile  
Series: Fabrique  
Color: Noir Linen (Unpolished)  
Color #: P689  
Size: 12" x 24"

**GROUT:**  
Manufacturer: Mapei  
Color: 47 Charcoal

#### Wall Primary



**TILE:**  
Manufacturer: Daltile  
Series: Colour Scheme  
Color: Biscuit  
Color #: B903  
Size: 12" x 12"

**GROUT:**  
Manufacturer: Custom  
Building Products  
Color: 10 Antique White

#### Wall Accent



**TILE:**  
Manufacturer: Daltile  
Series: Colour Scheme  
Color: Galaxy Speckle  
Color #: B933  
Size: 12" x 12"

**GROUT:**  
Manufacturer: Custom  
Building Products  
Color: 10 Antique White

### COUNTERTOPS

#### Natural Stone



Manufacturer: Daltile  
Collection: Granite Slabs  
Color: Blue Pearl  
Color #: G703

#### Solid Surface

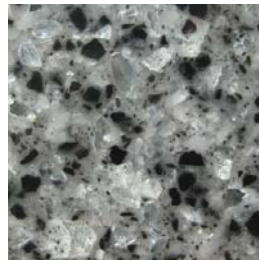

Manufacturer: Staron  
Color: Zenith  
Color #: FZ184

#### Plastic Laminate



Manufacturer: Nevamar  
Color: Calm Distinction  
Color #: VA6001T

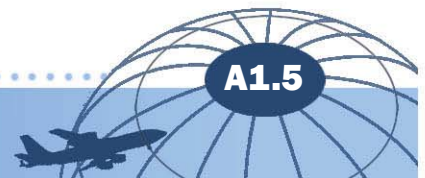

# APPENDIX ONE - TERMINAL COLOR BOARDS (WARM COLOR SCHEME)

## Paint

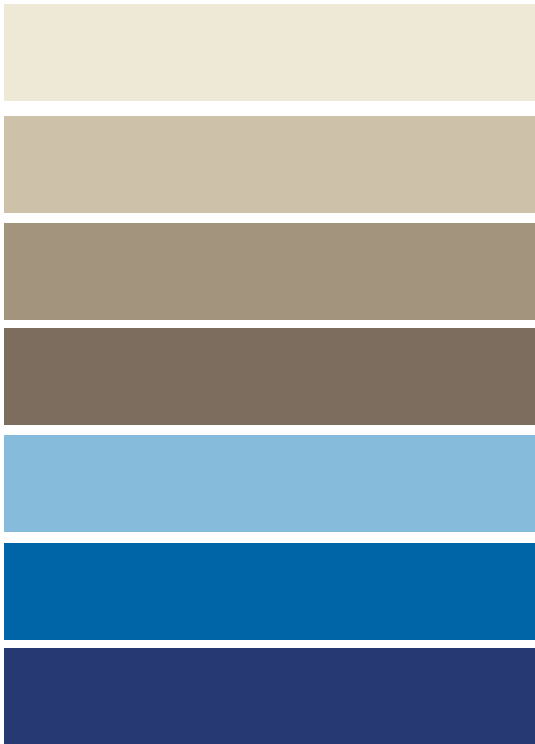

## Wall Coverings



## Acoustical Ceiling Tile Carpet Tile

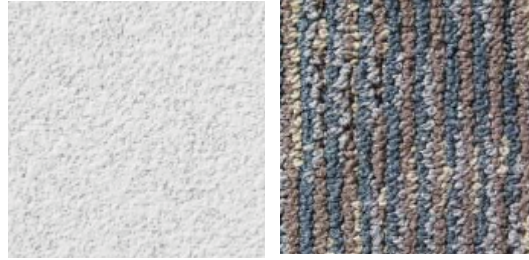

## Quarry Tile



## Sheet Vinyl

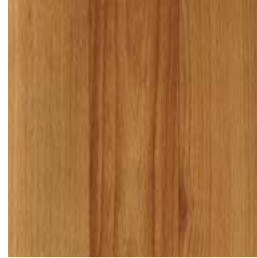

## Vinyl Composition Tile Stained Concrete



## Terrazzo Tile



## Terrazzo Tile

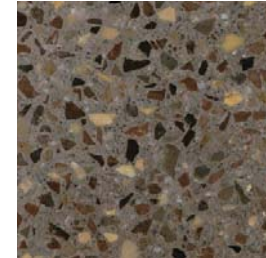

## Terrazzo Tile



## Restrooms: Ceramic Wall Tile

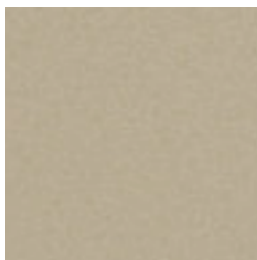

## Restrooms: Ceramic Wall Tile

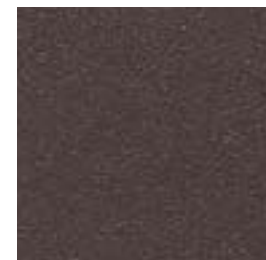

## Restrooms: Ceramic Floor Tile

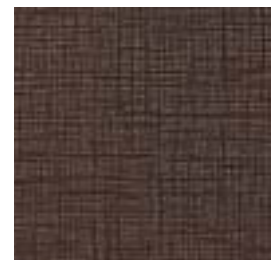

## Natural Stone



## Solid Surface



## Plastic Laminate





## APPENDIX ONE - TERMINAL COLOR BOARDS (WARM COLOR SCHEME)

### PAINT

---

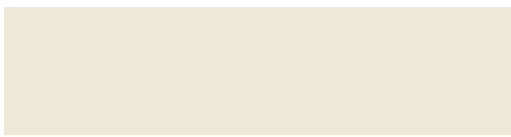

Manufacturer: Benjamin Moore  
Color: Navajo White\*  
Color #: 947



Manufacturer: Benjamin Moore  
Color: Bleeker Beige\*  
Color #: HC-80



Manufacturer: Benjamin Moore  
Color: Alexandria Beige\*  
Color #: HC-77



Manufacturer: Benjamin Moore  
Color: Whitall Brown\*  
Color #: HC-69

\* Option - color as shown available in a textured paint finish,  
Manufacturer: Scuffmasters, Series: Armor

### PAINT - AMC LOGO

---



Manufacturer: Benjamin Moore  
Color: Blue Marguerite  
Color #: 2063-50



Manufacturer: Benjamin Moore  
Color: Brilliant Blue  
Color #: 2065-30



Manufacturer: Benjamin Moore  
Color: Blue  
Color #: 2066-10



## APPENDIX ONE - TERMINAL COLOR BOARDS (WARM COLOR SCHEME)

### WALL COVERINGS

---

#### Primary 1



Manufacturer: Tower  
Collection: Seascape  
Color: Waikiki  
Color #: TR-SS-37

#### Accent 1



Manufacturer: Tower  
Collection: Conundrum  
Color: Perplexed  
Color #: TR-CN-05

#### Accent 2



Manufacturer: Versa  
Collection: Manhattan  
Square  
Color: Greenwich Village  
Color #: ASL-108548

#### Acoustical 1



Manufacturer: MDC  
Wall coverings  
Collection: Acoustical  
Resource  
Pattern: Stratford Crush  
Color: Oatmeal  
Pattern #: RSC-2016

#### Acoustical 2



Manufacturer: MDC Wall  
coverings  
Collection: Acoustical  
Resource  
Pattern: Stratford Rib  
Color: Java  
Pattern #: RSB-6833

#### Restrooms



Manufacturer: Len-Tex  
Collection: Coronado  
Color: Raffia  
Pattern #: 3610-CR

### ACOUSTICAL CEILING TILE

---



Manufacturer: USG  
Series: Mars Climaplus  
Item #: 86985  
2' x 2'

### HEAVY DUTY HAND RAIL

---

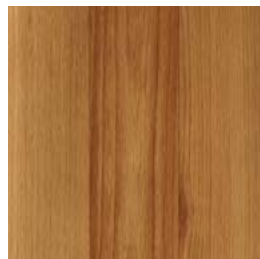

Manufacturer: InPro Corp.  
Collection: 3500MV  
Color: Honey Nut 0535



## APPENDIX ONE - TERMINAL COLOR BOARDS (WARM COLOR SCHEME)

### CARPET TILE & RUBBER BASE



**CARPET**  
Manufacturer: Atlas  
Collection: Amore di Arte  
Style: Antico  
Color: 40A0 Chocolate Block  
Installation: Monolithic



**RUBBER BASE**  
Manufacturer: Roppe  
Color: Light Brown  
Color #: 147

### TERRAZZO TILE

#### Primary



**TILE:**  
Manufacturer: Daltile  
Series: Micro  
Color: TZ15 - Gray Matter

**GROUT:**  
Manufacturer: Custom Building Products  
Color: 165 Delorean Gray

#### Accent 1

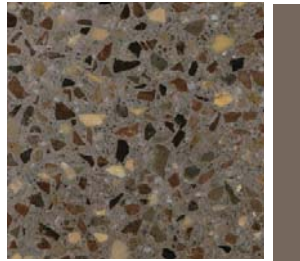

**TILE:**  
Manufacturer: Daltile  
Series: Micro  
Color: TZ11 - Mercury Rising

**GROUT:**  
Manufacturer: Mapei  
Color: 04 Bahama Beige

#### Accent 2

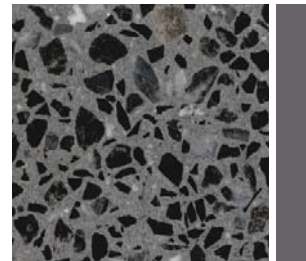

**TILE:**  
Manufacturer: Daltile  
Series: Micro  
Color: TZ16 - Eclipse

**GROUT:**  
Manufacturer: Custom Building Products  
Color: 19 Pewter

### STAINED CONCRETE



Manufacturer: Concrete Earth  
Collection: Ocera Stain Series  
Style: Opus  
Color: Sand

### QUARRY TILE



Manufacturer: American Olean  
Collection: Quarry Naturals  
Color: Desert N03  
(with abrasive grain)

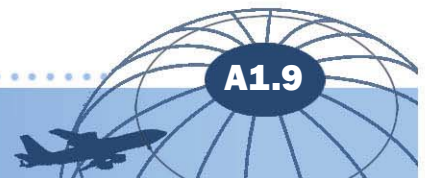

## APPENDIX ONE - TERMINAL COLOR BOARDS (WARM COLOR SCHEME)

### VINYL FLOORING



Manufacturer: Johnsonite  
Collection: Acczent Finishes  
Color: Light Cherry  
Color #: 6007  
Style: Vinyl Sheet



Manufacturer: Azrock  
Series: Cortina Grande  
Color: Camel  
Color #: CG410  
Style: 16" x 16" Solid Vinyl Tile

### CERAMIC TILE

#### Floor

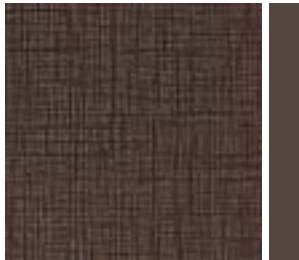

**TILE:**  
Manufacturer: Daltile  
Series: Kimona Silk  
Color: Chai Tea  
Color #: P324  
Size: 12" x 24"

**GROUT:**  
Manufacturer: Mapei  
Color: 07 Chocolate

#### Wall Primary

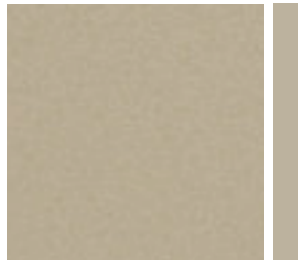

**TILE:**  
Manufacturer: Daltile  
Series: Colour Scheme  
Color: Urban Putty  
Color #: B902  
Size: 12" x 12"

**GROUT:**  
Manufacturer: Mapei  
Color: 39 Ivory

#### Wall Accent



**TILE:**  
Manufacturer: Daltile  
Series: Colour Scheme  
Color: Artisan Brown  
Color #: B909  
Size: 12" x 12"

**GROUT:**  
Manufacturer: Mapei  
Color: 39 Ivory

### COUNTERTOPS

#### Natural Stone



Manufacturer: Daltile  
Collection: Granite Slabs  
Color: Cafe Imperial  
Color #: G763

#### Solid Surface



Manufacturer: Staron  
Color: Adamantine  
Color #: FA159

#### Plastic Laminate



Manufacturer: Nevamar  
Color: Visible Vava  
Color #: VA2001T



APPENDIX TWO - FAMILY LOUNGE COLOR BOARDS (SCHEME 1)



FABRIC

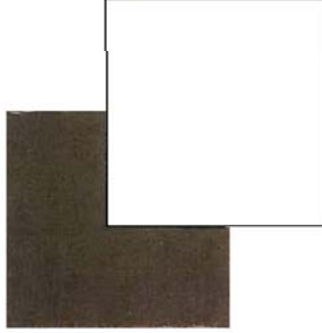
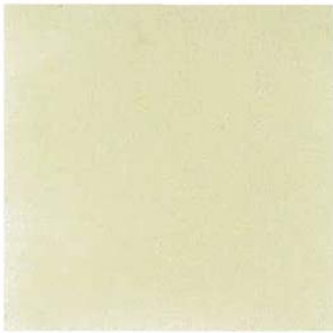

RESTROOM TILE-WALL



COUNTERTOP



COLOR PALETTE



RESTROOM TILE-FLOOR



VINYL FLOORING

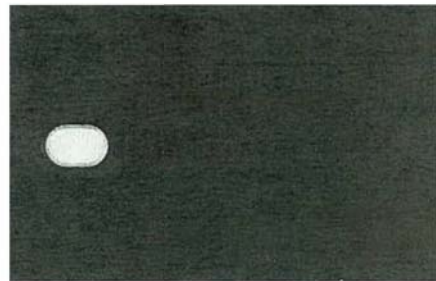

CABINETSRY LAMINATE



DOOR



WALL BASE

## APPENDIX TWO - FAMILY LOUNGE COLOR BOARDS (SCHEME 1)

<b>Primary Paint</b>	<b>Sherwin Williams</b> SW 6386 - Napery
<b>Accent Paint</b>	<b>Sherwin Williams</b> SW 6662 - Summer Day SW 2801 - Rookwood Dark Red SW 6642 - Rhumba Orange SW 6573 - Juneberry
<b>Vinyl / Wood Floor</b>	<b>Lonseal Vinyl</b> Lonwood Natural - 452 Maple Syrup
<b>Wall Base</b>	<b>Johnsonite</b> 85 Burgundy
<b>Countertop</b>	<b>Dupont Zodiac</b> Rosso Verona
<b>Countertop Laminate</b>	<b>Wilsonart</b> 4859-60 Spiced Zephyr
<b>Fabrics</b>	<b>Momentum Crypton Fabric</b> Assemblage Ember (couch) Brea Tiger Lilly (bar stools) Brea Cranberry (bar stools) Brea Copper (bar stools) Brea Tiger Lilly (chair) Assemblage Vermillion (chair)
<b>Cabinetry Laminate</b>	<b>Wilsonart</b> 7040K-78 Figured Mahogany
<b>Tile - Floor</b>	<b>Daltile</b> Colorbody - Veranda - Rust P502
<b>Tile - Field Wall</b>	<b>Daltile</b> Matte - Crisp Linen 0739
<b>Tile - Accent Wall</b>	<b>Daltile</b> Festiva - Pecan QF50



APPENDIX TWO - FAMILY LOUNGE COLOR BOARDS (SCHEME 2)



FABRIC

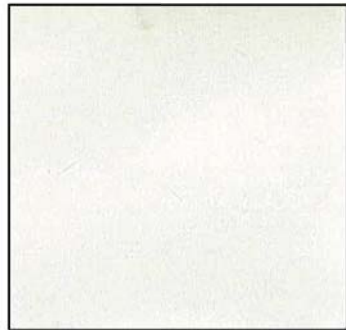

RESTROOM TILE-WALL

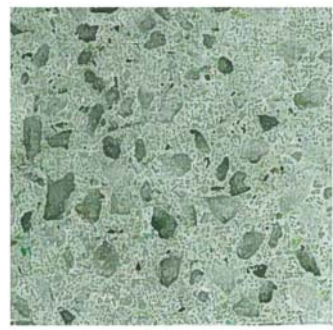

COUNTERTOP



COLOR PALETTE



RESTROOM TILE-FLOOR



VINYL FLOORING

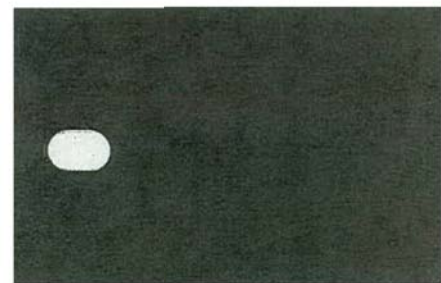

CABINETS LAMINATE



DOOR



WALL BASE

## APPENDIX TWO - FAMILY LOUNGE COLOR BOARDS (SCHEME 2)

<b>Primary Paint</b>	<b>Sherwin Williams</b> SW 6427 - Sprout
<b>Accent Paint</b>	<b>Sherwin Williams</b> SW 6493 - Ebbtide SW 6509 - Georgian Bay SW 2827 - Colonial Revival Stone SW 7027 - Well-Bred Brown
<b>Vinyl / Wood Floor</b>	<b>Johnsonite</b> 3005 Maple
<b>Wall Base</b>	<b>Johnsonite</b> 47 Brown
<b>Countertop</b>	<b>Dupont Zodiac</b> Wintergreen
<b>Countertop Laminate</b>	<b>Wilsonart</b> 4867-52 Jeweled Mica
<b>Fabrics</b>	<b>Momentum Crypton Fabric</b> Buzz Sea (couch) Jax Spa (chair) Smart Suede Gumball (chair) Brea Larkspur (stool) Brea Aloe (stool) Brea Spring Green (stool)
<b>Cabinetry Laminate</b>	<b>Wilsonart</b> 7040K-78 - Figured Mahogany
<b>Tile - Floor</b>	<b>Daltile</b> Colorbody - Veranda - Gravel P501
<b>Tile - Field Wall</b>	<b>Daltile</b> Matte - Urban Putty 0761
<b>Tile - Accent Wall</b>	<b>Daltile</b> Matte Elemental - Tan 0766





APPENDIX TWO - FAMILY LOUNGE COLOR BOARDS (SCHEME 3)

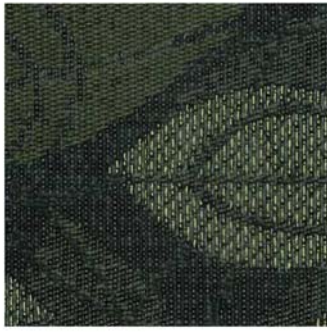

FABRIC

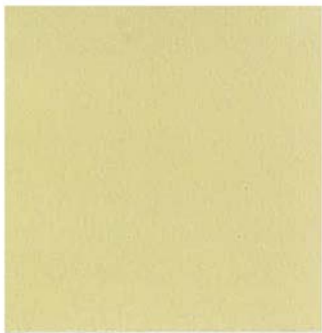

COLOR PALETTE

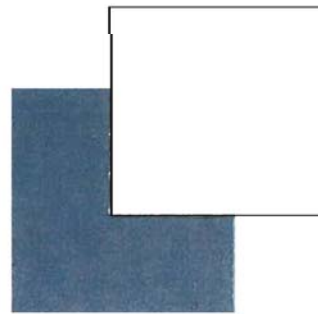

RESTROOM TILE-WALL



COUNTERTOP



RESTROOM TILE-FLOOR



VINYL FLOORING

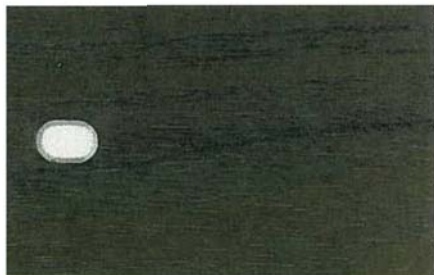

CABINETS/LAMINATE



DOOR



WALL BASE



## APPENDIX TWO - FAMILY LOUNGE COLOR BOARDS (SCHEME 3)

<b>Primary Paint</b>	<b>Sherwin Williams</b> SW 6127 - Ivoire
<b>Accent Paint</b>	<b>Sherwin Williams</b> SW 6250 - Granite Peak SW 6232 - Misty SW 6804 - Dignity Blue SW 6109 - Hopsack
<b>Vinyl / Wood Floor</b>	<b>Johnsonite</b> 3003 Medium Beech
<b>Wall Base</b>	<b>Johnsonite</b> 18 Navy Blue
<b>Countertop</b>	<b>Dupont Zodiac</b> Eclipse Blue
<b>Countertop Laminate</b>	<b>Wilsonart</b> 4894K-01 Girona Falls
<b>Fabrics</b>	<b>Momentum Crypton Fabric</b> Topanga Eve (couch) Sway Eve (chair) Fleck Evening Fog (chair/stool) Smart Suede Malt (stool) Fleck Capri (stool)
<b>Cabinetry Laminate</b>	<b>Wilsonart</b> 7110K-78 Montana Walnut
<b>Tile - Floor</b>	<b>Daltile</b> Colorbody - Veranda - Titanium P523
<b>Tile - Field Wall</b>	<b>Daltile</b> Modern Dimensions - Matte Biscuit K775
<b>Tile - Accent Wall</b>	<b>Daltile</b> Festiva - Chambray QF68



APPENDIX TWO - FAMILY LOUNGE COLOR BOARDS (SCHEME 4)



FABRIC

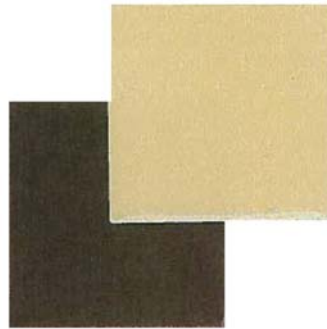
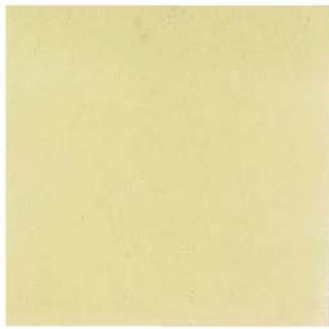

RESTROOM TILE-WALL



COUNTERTOP



COLOR PALETTE



RESTROOM TILE-FLOOR



VINYL FLOORING



CABINETY LAMINATE



DOOR



WALL BASE

## APPENDIX TWO - FAMILY LOUNGE COLOR BOARDS (SCHEME 4)

<b>Primary Paint</b>	<b>Sherwin Williams</b> SW 6372 - Inviting Ivory
<b>Accent Paint</b>	<b>Sherwin Williams</b> SW 6076 - Turkish Coffee SW 2839 - Roycroft Copper Red SW 2803 - Rockwood Terra Cotta SW 2831 - Classical Gold
<b>Vinyl / Wood Floor</b>	<b>Johnsonite</b> 3025 Brushed Oak Dark
<b>Wall Base</b>	<b>Johnsonite</b> 264 Grounded
<b>Countertop</b>	<b>Dupont Zodiac</b> Vela Brown
<b>Countertop Laminate</b>	<b>Wilsonart</b> 4854-38 Mission Glaze
<b>Fabrics</b>	<b>Momentum Crypton Fabric</b> Feliz Espresso (couch)  <b>Pallas</b> Grasmere - 29.020.038 Amber (chair/bar stool) Grasmere - 29.020.011 Summer Sun (bar stool) Grasmere - 29.020.081 Dirty Blonde (bar stool) Grasmere - 29.023.079 Earth (chair)
<b>Cabinetry Laminate</b>	<b>Wilsonart</b> 7929-38 Huntington Maple
<b>Tile - Floor</b>	<b>Daltile</b> Colorbody - Veranda - Copper P526
<b>Tile - Field Wall</b>	<b>Daltile</b> Festiva - Chiffon QF06
<b>Tile - Accent Wall</b>	<b>Daltile</b> Festiva - Pecan QF50



APPENDIX TWO - FAMILY LOUNGE COLOR BOARDS (SCHEME 5)

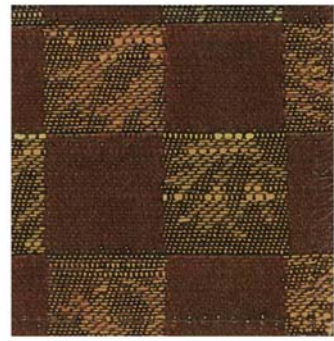

FABRIC



COLOR PALETTE

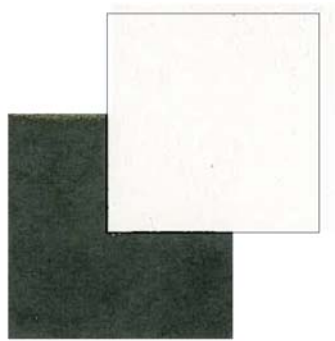

RESTROOM TILE-WALL



COUNTERTOP



RESTROOM TILE-FLOOR



VINYL FLOORING

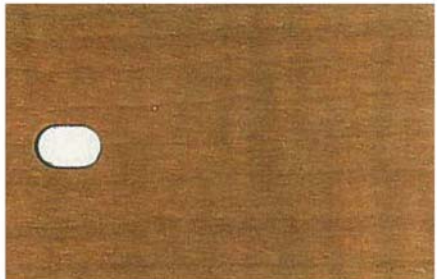

CABINETY LAMINATE



DOOR



WALL BASE

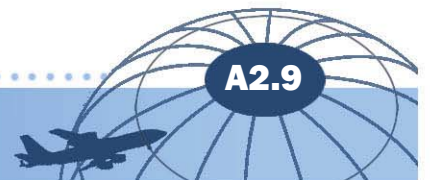

## APPENDIX TWO - FAMILY LOUNGE COLOR BOARDS (SCHEME 5)

<b>Primary Paint</b>	<b>Sherwin Williams</b> SW 6373 - Harvester
<b>Accent Paint</b>	<b>Sherwin Williams</b> SW 7034 - Status Bronze SW 6426 - Basque Green SW 6342 - Spicy Hue SW 6398 - Sconce Gold
<b>Vinyl / Wood Floor</b>	<b>Johnsonite</b> 3021 Ipe
<b>Wall Base</b>	<b>Johnsonite</b> 166 Sienne
<b>Countertop</b>	<b>Dupont Zodiac</b> Maronne Emperador
<b>Countertop Laminate</b>	<b>Wilsonart</b> Antique Copper LS D494-60
<b>Fabrics</b>	<b>Pallas</b> Delphinium - 29.021.048 Persimmon (chair) Mache - 29.023.057 Plum (couch) Grasmere - 29.020.029 Rusted Nail (chair/bar stool) Grasmere - 29.020.047 Clove (stool) Grasmere - 29.020.038 Amber (stool) Grasmere - 29.020.011 Summer Sun (stool)
<b>Cabinetry Laminate</b>	<b>Wilsonart</b> 7925-38 Monticello Maple
<b>Tile - Floor</b>	<b>Daltile</b> Colorbody - Veranda - Gold P521
<b>Tile - Field Wall</b>	<b>Daltile</b> Matte - Crisp Linen 0739
<b>Tile - Accent Wall</b>	<b>Daltile</b> Festiva - Root Beer QF27



# APPENDIX THREE - FLIGHT CHECK-IN COUNTER

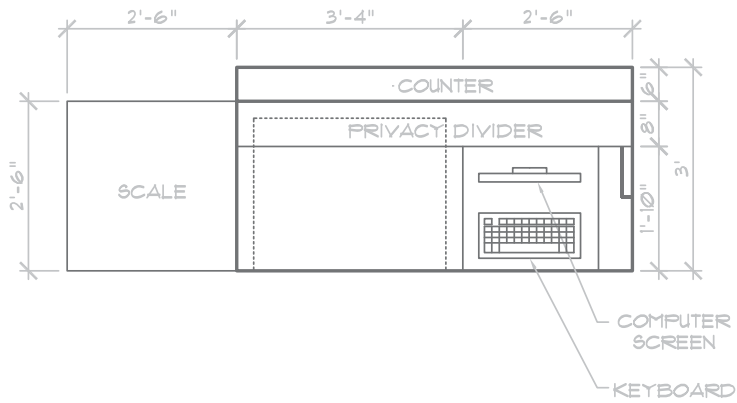

**1** PLAN  
NTS

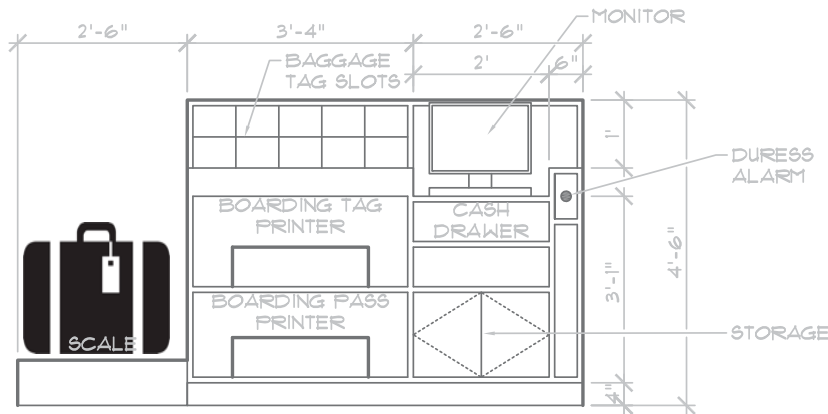

**2** REAR ELEVATION  
NTS

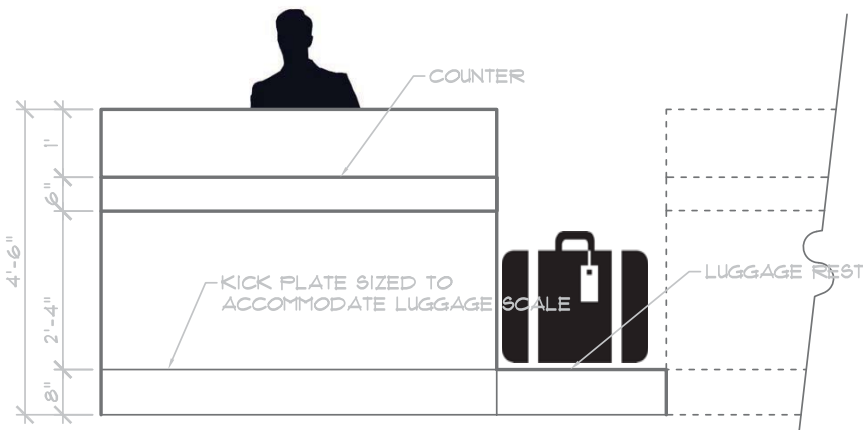

**3** FRONT ELEVATION  
NTS

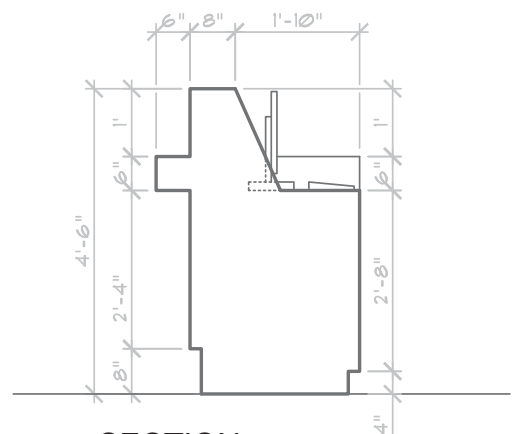

**4** SECTION  
NTS



# APPENDIX THREE - PASSENGER SERVICE COUNTER

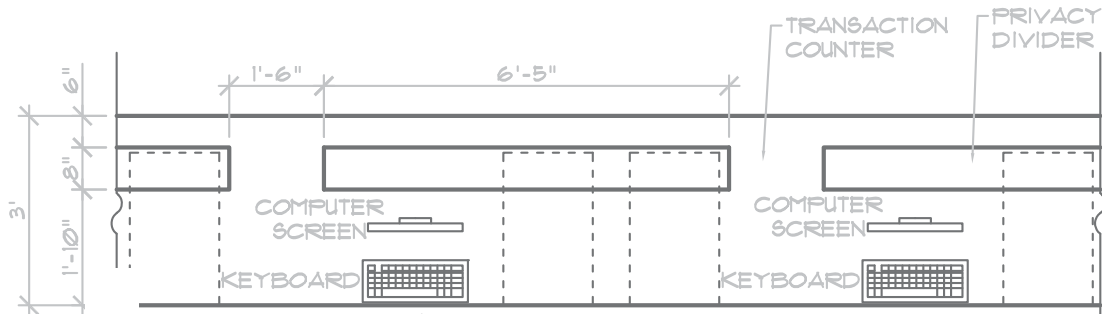

**1** PLAN  
NTS

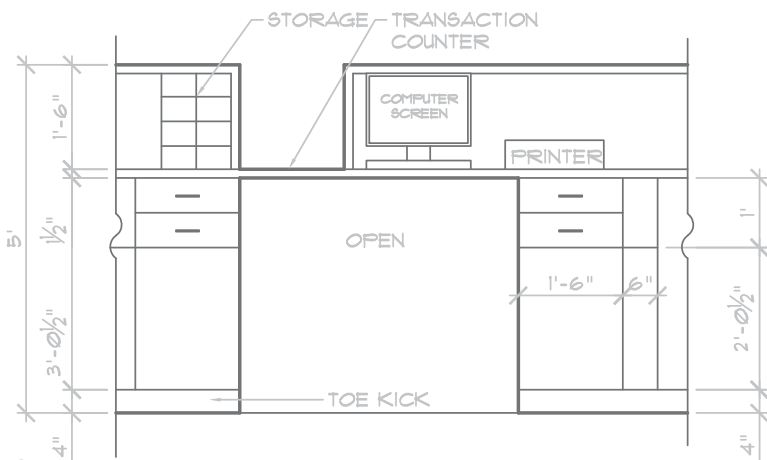

**2** REAR ELEVATION  
NTS

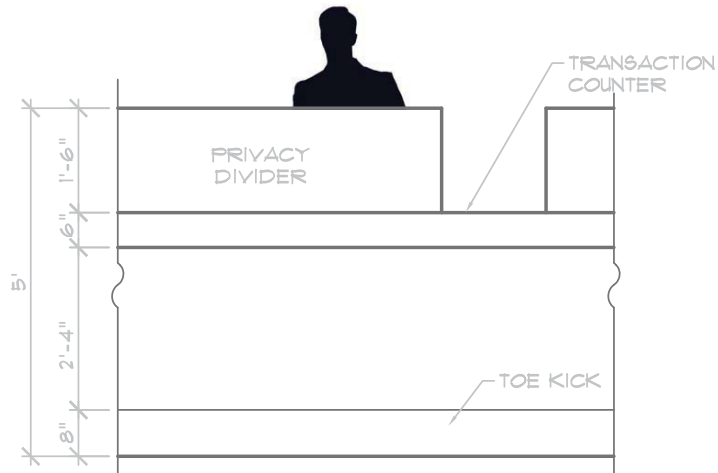

**3** FRONT ELEVATION  
NTS

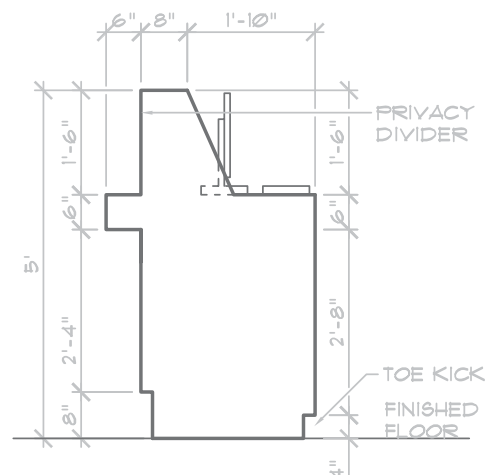

**4** SECTION  
NTS





# APPENDIX THREE - CUSTOMS COUNTER

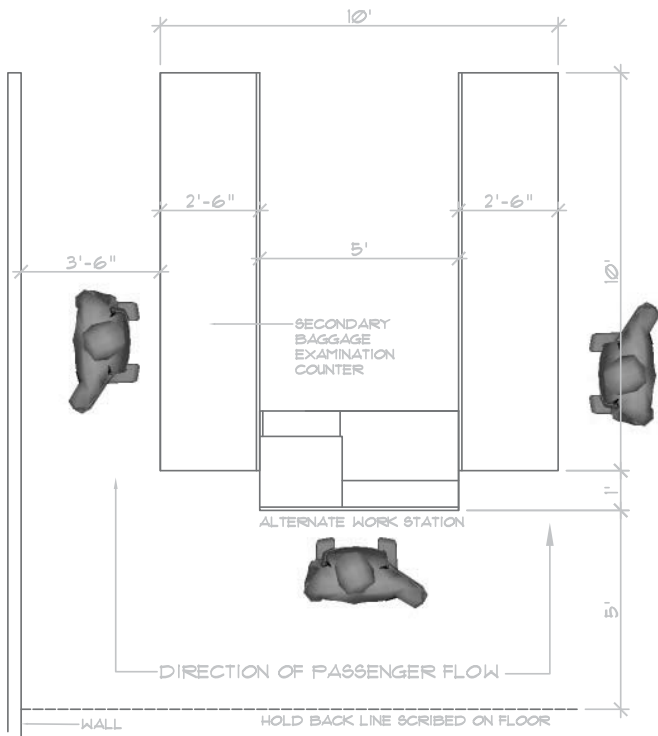

**1** PLAN  
NTS

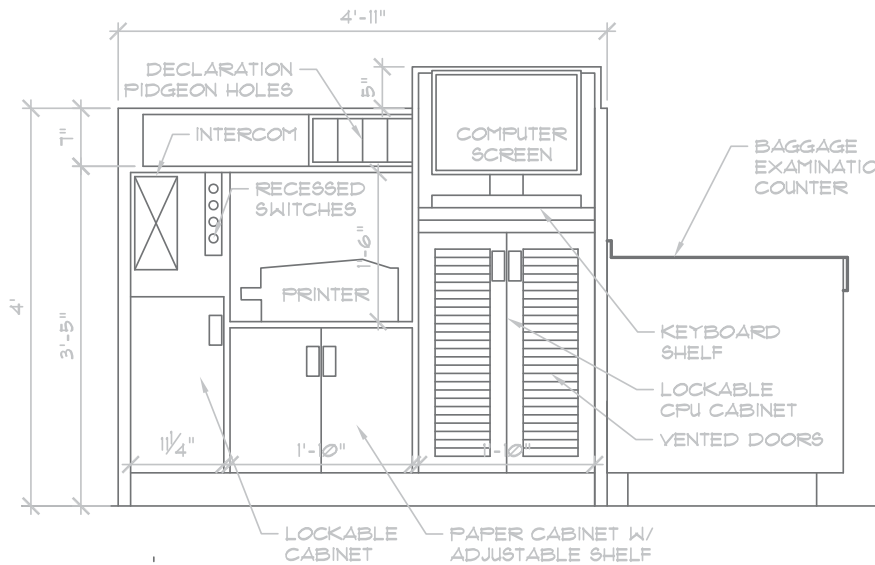

**2** REAR ELEVATION  
NTS

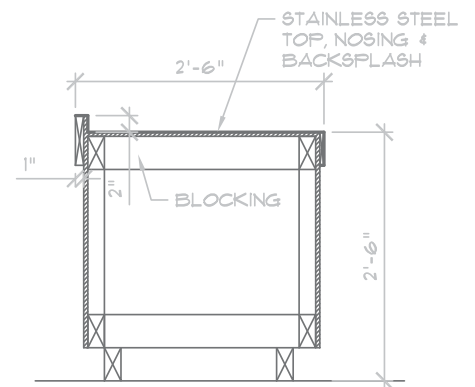

**3** SECTION  
NTS

# APPENDIX THREE - SECONDARY WRITING COUNTER AND WORKSTATION

NOTE:  
DEPTH OF OPTIONAL  
WRITING COUNTER IS 2'-0"

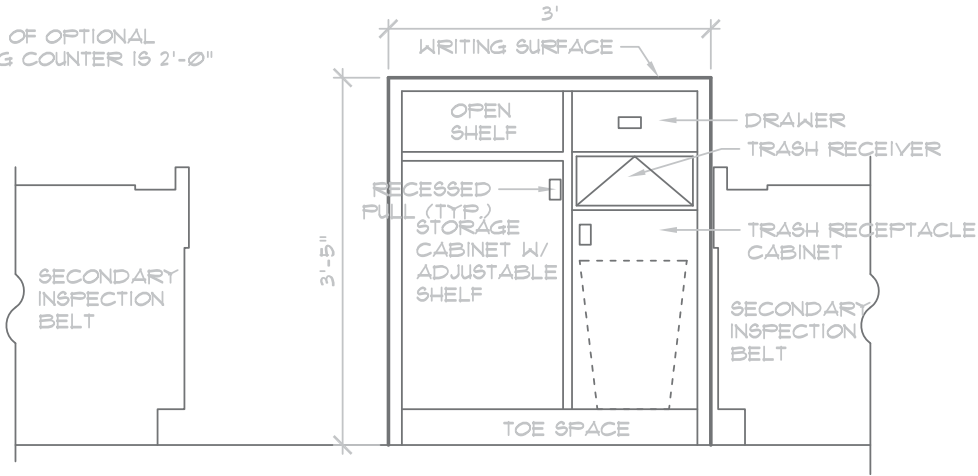

**1** REAR ELEVATION  
NTS

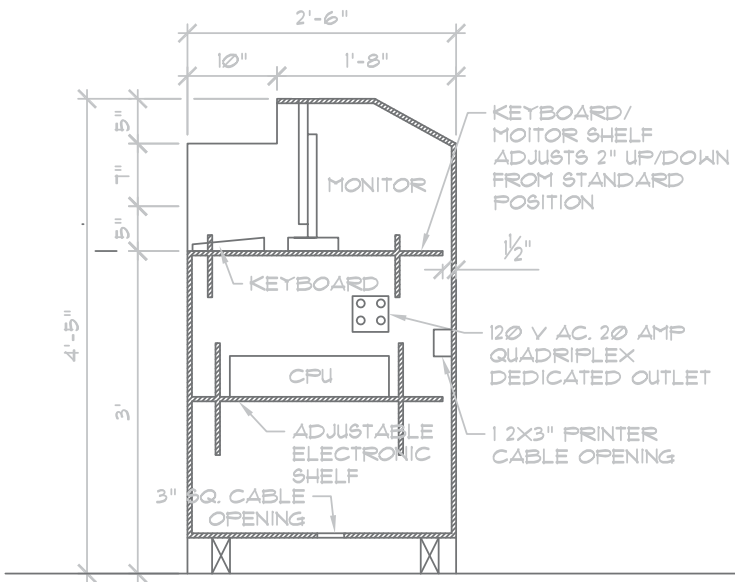

**2** SECTION  
NTS

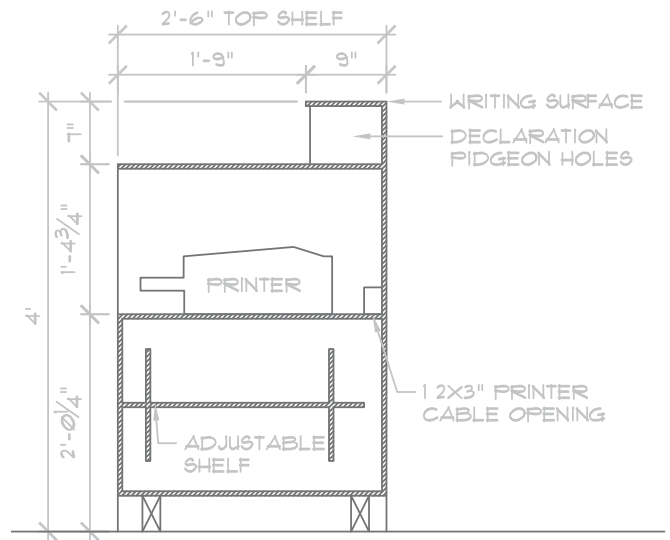

**3** SECTION  
NTS



# APPENDIX FOUR - NOTIONAL LARGE TERMINAL (FIRST AND SECOND FLOOR PLANS - NTS)

## Upper Level

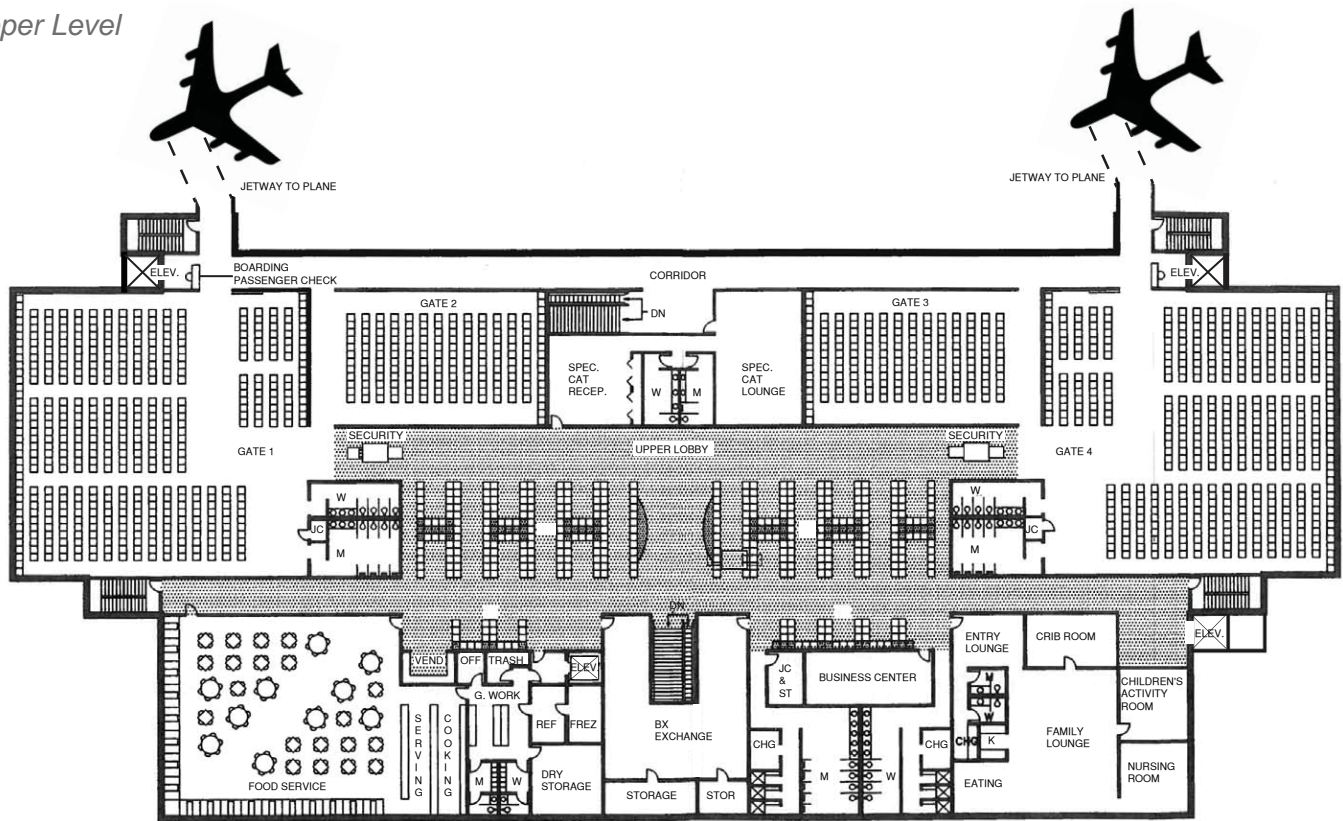

## Lower Level

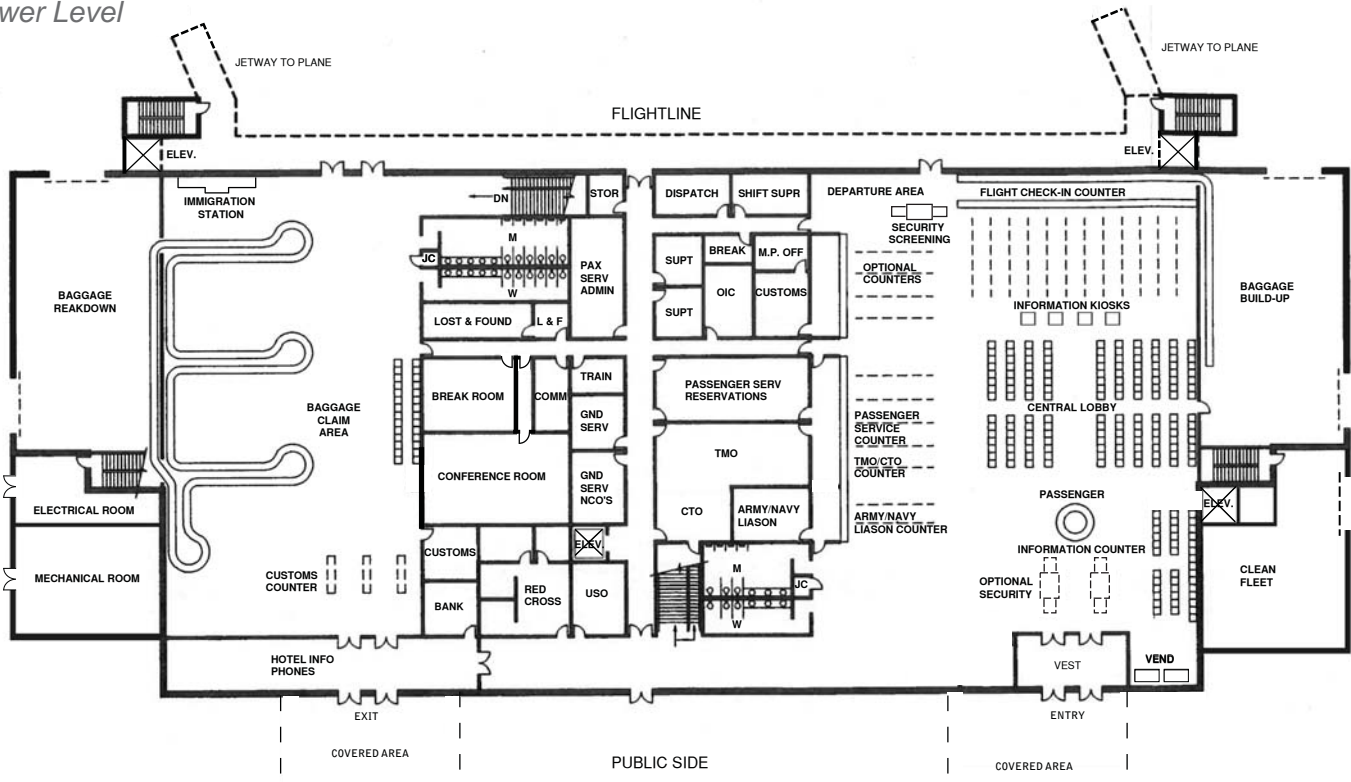

# APPENDIX FOUR - NOTIONAL MEDIUM TERMINAL FLOOR PLAN (NTS)

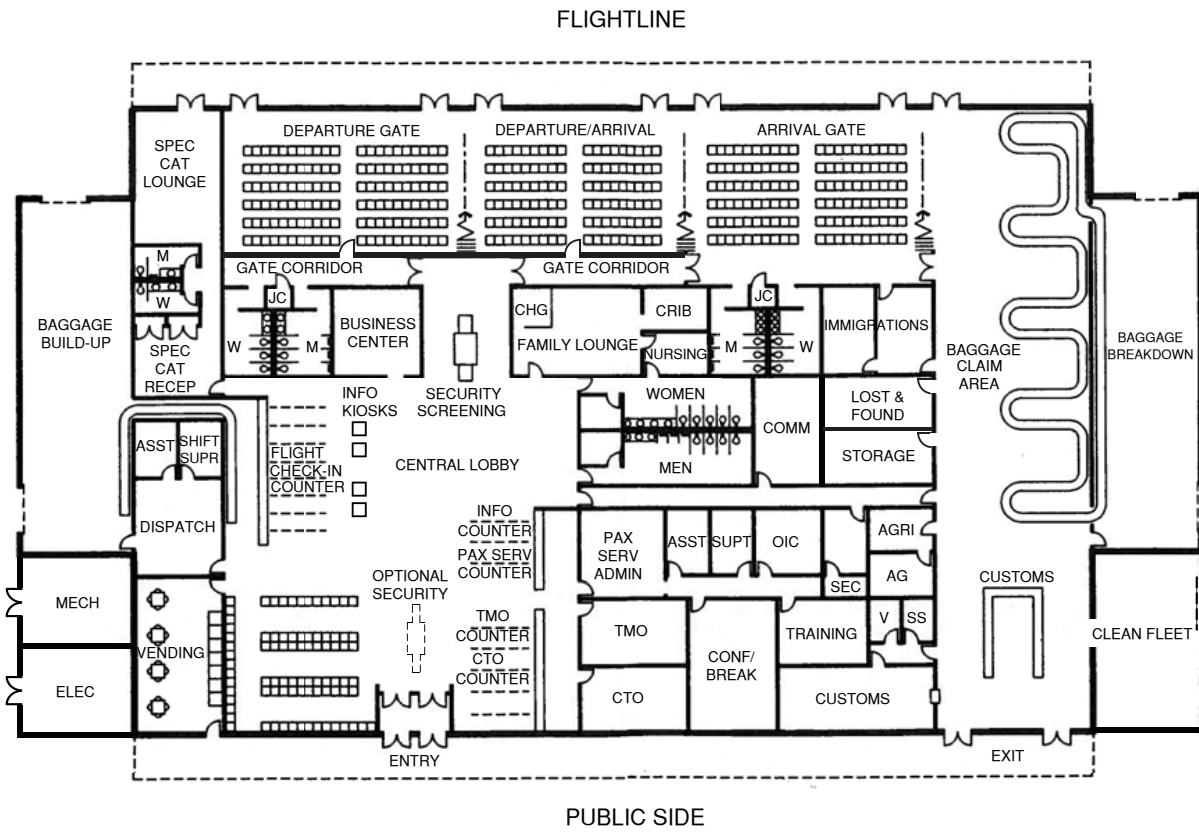

# APPENDIX FOUR - NOTIONAL SMALL TERMINAL FLOOR PLANS (NTS)

*Type 1A*

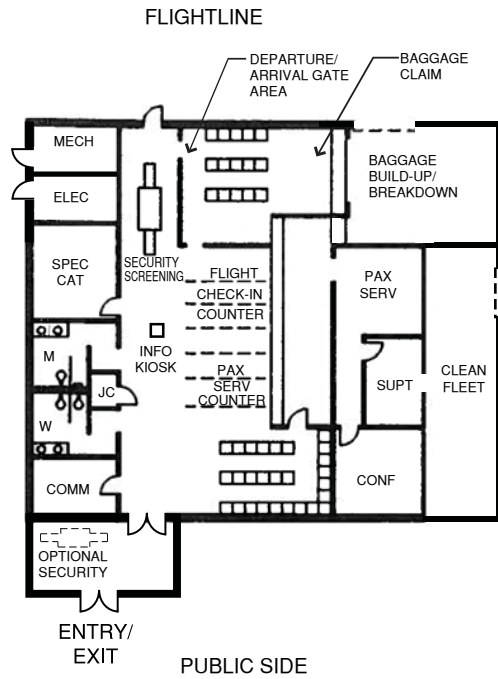

*Type 1B*

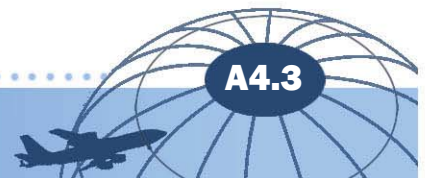
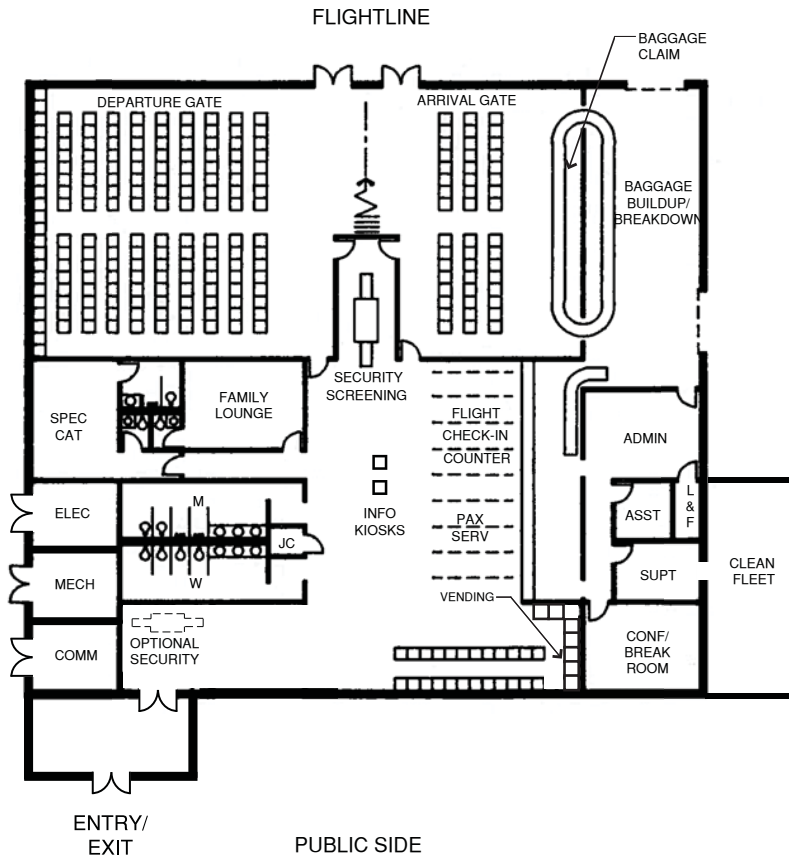



**A4.4**

## APPENDIX FIVE - GENERAL REFERENCES

### Department of Defense & Air Force Publications

AFM 32-1084	Facility Requirements
AFI 31-210	The Air Force Anti-Terrorism (AT) Program
AFI 10-245	Antiterrorism
AFJMAN 32-1008	Installation Design Guide
AFJMAN 32-1071	Security Engineering, Volume 1, 2, 3
AMCI 24-101, Vol.14	Military Airlift Passenger Service
MIL-HDBK-1190	Facility Planning and Design Guide Air Force Environmentally Responsible Facilities Guide AMC Commanders Guide to Facility Excellence AMC Flightline Security Standards AMC Interior Design Guide
ETL 93-02	AMC Sign Standards Department of Defense Anti-Terrorism Construction Standards Local Base Architectural Compatibility Plan USAF Installation Force Protection Guide
UFC 1-200-01	Design: General Building Requirements
UFC 3-120-01	Air Force Sign Standards
UFC 4-030-01	Sustainable Development
UFC 4-010-01 DOD	Minimum Anti-terrorism Standards for Buildings
UFC 4-010-02 DOD	Minimum Anti-terrorism Standoff Distances for Buildings
MIL-HDBK 1008	Fire Protection for Facilities Engineering, Design and Construction

### Other Publications

ABA	Architectural Barriers Act of 1968
IBC	International Building Code
NFPA 101	Life Safety Code
OSHA	Occupational Safety and Health Administration

### Reference Manual

National Bureau of Standards Handbook 135, Life Cycle Cost Manual for Federal Energy Management  
U.S Customs Service Technical Standards for Passenger Processing at Airports



August 2011